

Cirio Circular

Antoni Arola. 2010
Pendant lamps



Porcelain



Glass



Brass

Circular S



A

Circular M

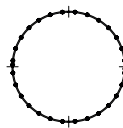

B

Circular L

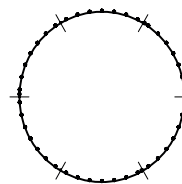

C

Oval

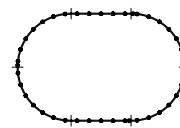

D



The polyvalent structure of Cirio Circular and Cirio Oval allows for circles with differing diameters to produce a range of formats. Cirio Oval combines straight lines and semi-circles, producing lamps that are as large as necessary.

The shade, beautifully designed, is reminiscent of a candle for its shape, texture and the warmth of its light. The varying shades combined with LED capsules can be used to create different atmospheres: from the porcelain of Sargadelos (Galicia, Spain) that creates candle-like warmth, to translucent opal glass, and the opaque elegance of brass.

Cirio is a system that provides customisable solutions for vertical lighting by combining structures, shades and light textures. The pendant lamp can be used alone or arranged in rows or clusters to illuminate larger areas, in forms such as the Chandelier, Cascada, Circular, Linear, Oval or Múltiple. A perfect combination of repeated elements. The fusion of technology and tradition; innovation through craftsmanship. A truly unique lighting experience.

General description:

Capsule with LED module, translucent white diffuser and heat sink with black matte finish.

3 lampshade options: white porcelain, white opal glass and polished brass.

2 options of adjustable black metallic canopy with built-in equipment: circular (CE Market): regulation DALI / DSI / SWITCH DIM, or rectangular: regulation 1-10V / DALI. Not included external dimmer switch.

Black aluminium circular structure:

(A) \varnothing 130 cm / 51.1" for 12 lampshades.

(B) \varnothing 300 cm / 118.1" for 28 lampshades.

(C) \varnothing 520 cm / 204.7" for 42 lampshades.

(D) Combination of the linear and circular M (\varnothing 300 cm / 118.1") models.

Suitable for Junction Box (UL market).

Electric cable length: 5 m / 196.8

Approximate weight (unpacked):

(A) Circular S: 13 Kg / 28.6 lb

(B) Circular M: 33 Kg / 72.8 lb

(C) Circular L: 47 Kg / 103.5 lb

(D) Oval: 46 Kg / 101.5 lb

Lampshades:

Porcelain: 0,5 kg / 1.1 lb

Glass: 0,6 kg / 1.3 lb

Brass: 0,3 Kg / 0.7 lb

Cirio Circular

Antoni Arola. 2010
Pendant lamps

Technical information:

Light source included (dimmable):
LED module

Circular canopy (CE market):

Rated input wattage (LED capsule): 3,7 W
Operating current: 350 mA
Colour Temp.: 2.700 K
CRI: 90
Lifetime: 40.000 h

(A) 12 light sources
Rated input wattage: 44,4 W
Luminous flux:
Porcelain 1.464 lm
Glass 4.992 lm
Brass 1.572 lm

(B) 28 light sources
Rated input wattage: 103,6 W
Luminous flux:
Porcelain 3.416 lm
Glass 11.648 lm
Brass 3.668 lm

(C) 42 light sources
Rated input wattage: 155,4 W
Luminous flux:
Porcelain 5.124 lm
Glass 17.472 lm
Brass 5.502 lm

(D) 28 + 5 + 5 light sources
Rated input wattage: 140,6 W
Luminous flux:
Porcelain 4.636 lm
Glass 15.808 lm
Brass 4.978 lm

Rectangular canopy:

Rated input wattage (LED capsule): 7,7 W
Operating current: 700 mA
Colour Temp.: 2.700 K
CRI: 90
Lifetime: 40.000 h

(A) 12 light sources
Rated input wattage: 92,4 W
Luminous flux:
Porcelain 2.664 lm
Glass 7.860 lm
Brass 2.844 lm

(B) 28 light sources
Rated input wattage: 215,6 W
Luminous flux:
Porcelain 6.216 lm
Glass 18.340 lm
Brass 6.636 lm

(C) 42 light sources
Rated input wattage: 323,4 W
Luminous flux:
Porcelain 9.324 lm
Glass 27.510 lm
Brass 9.954 lm

(D) 28 + 5 + 5 light sources
Rated input wattage: 292,6 W
Luminous flux:
Porcelain 8.436 lm
Glass 24.890 lm
Brass 9.006 lm

Built-in LED.

Suitable for dimming 1-10V. (Not included external dimmer switch 1-10V).

Energy efficiency class (E.E.C): A++...A.

Suitable only for indoor use.

Input voltage: 120 ~ 277 Vac.

(50 Hz / 60 Hz). According to destination.

White porcelain lampshade

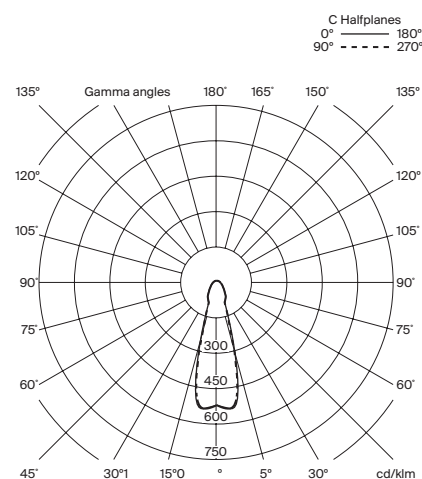

White opal glass lampshade

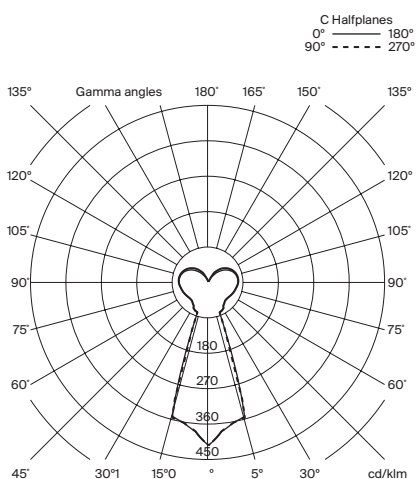

Brass lampshade

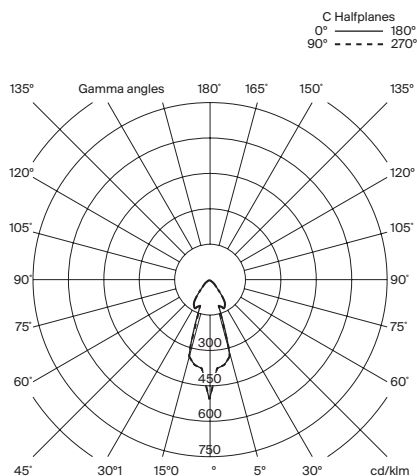

Regulations:

CE
UNE-EN 60598
UNE-EN 55015
UNE-EN 62031
UNE-EN 60529
UNE-EN 61000-3-2

UL
Dry and damp location
UL-1598
UL-8750
E-336377

Maintenance:

Clean with a smooth cloth. Do not use ammonia, solvents or abrasive cleaning products.

Others:

The lamp is delivered in different packages.
The assembly instructions are delivered with the product.

Model: Lampshades

White porcelain

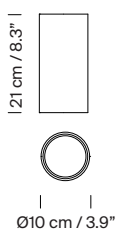

White opal glass

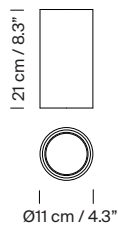

Brass

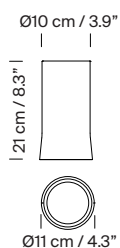

Model A: Cirio Circular S

Circular canopy (CE market)

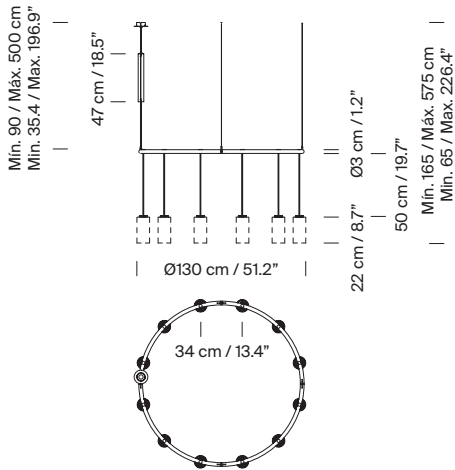

Rectangular canopy

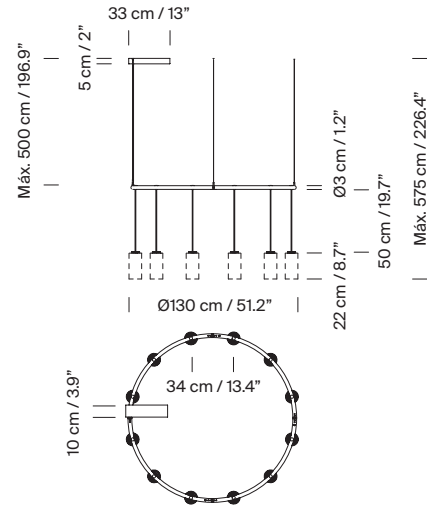

Model B: Cirio Circular M

Circular canopy (CE market)

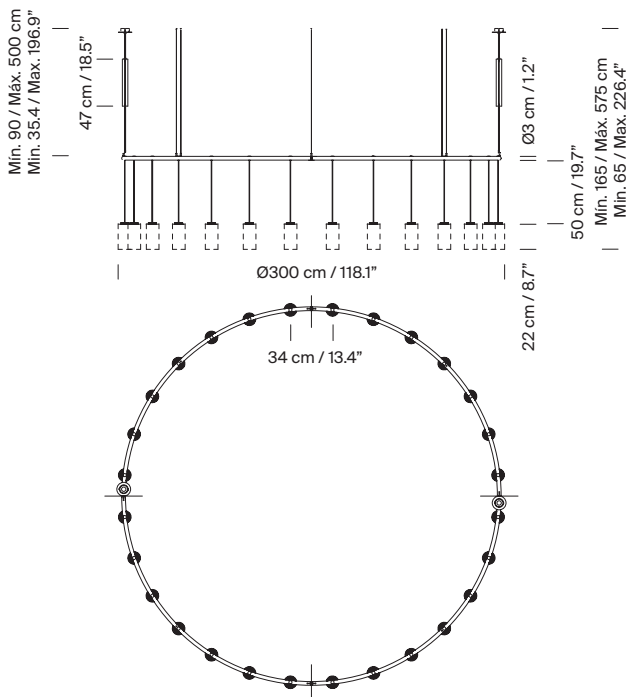

Rectangular canopy

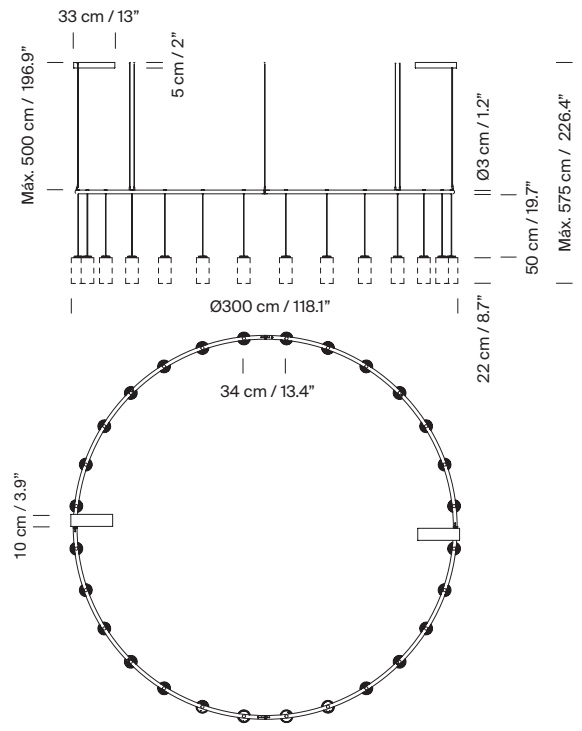

Model C: Cirio Circular L

Circular canopy (CE market)

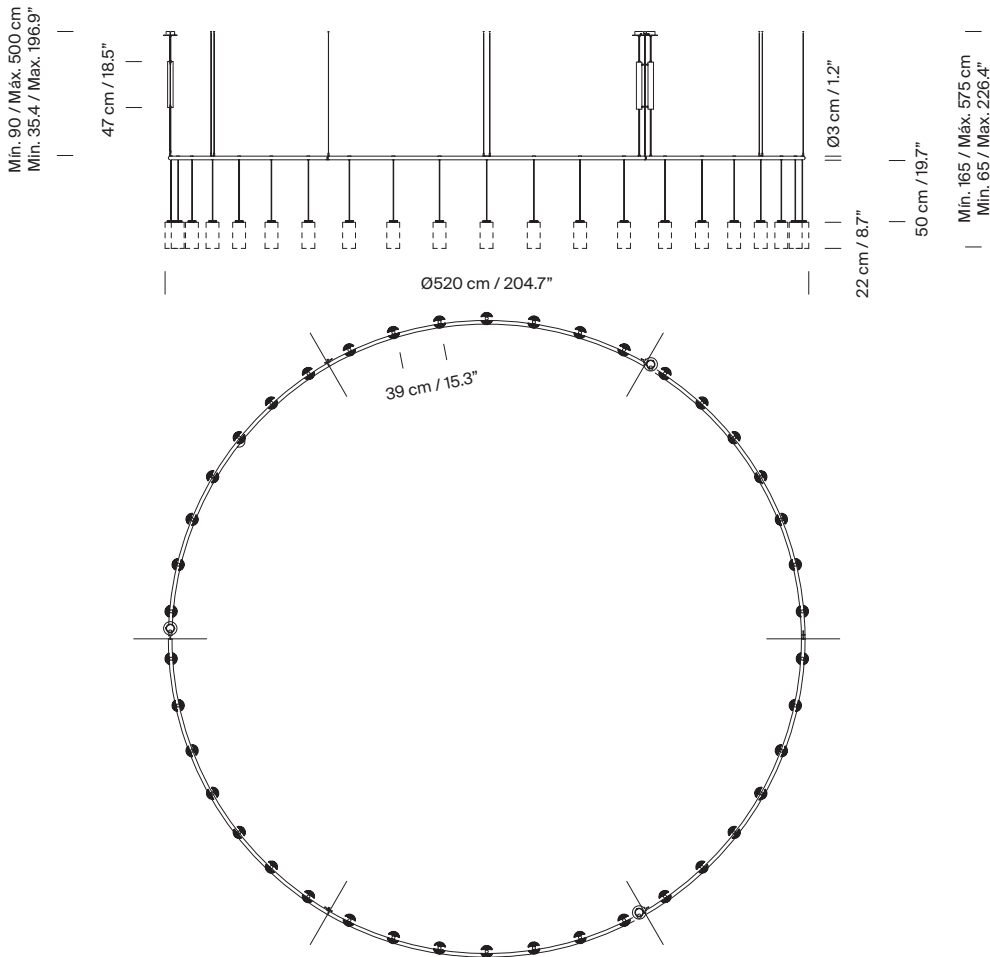

Model C: Cirio Circular L

Rectangular canopy

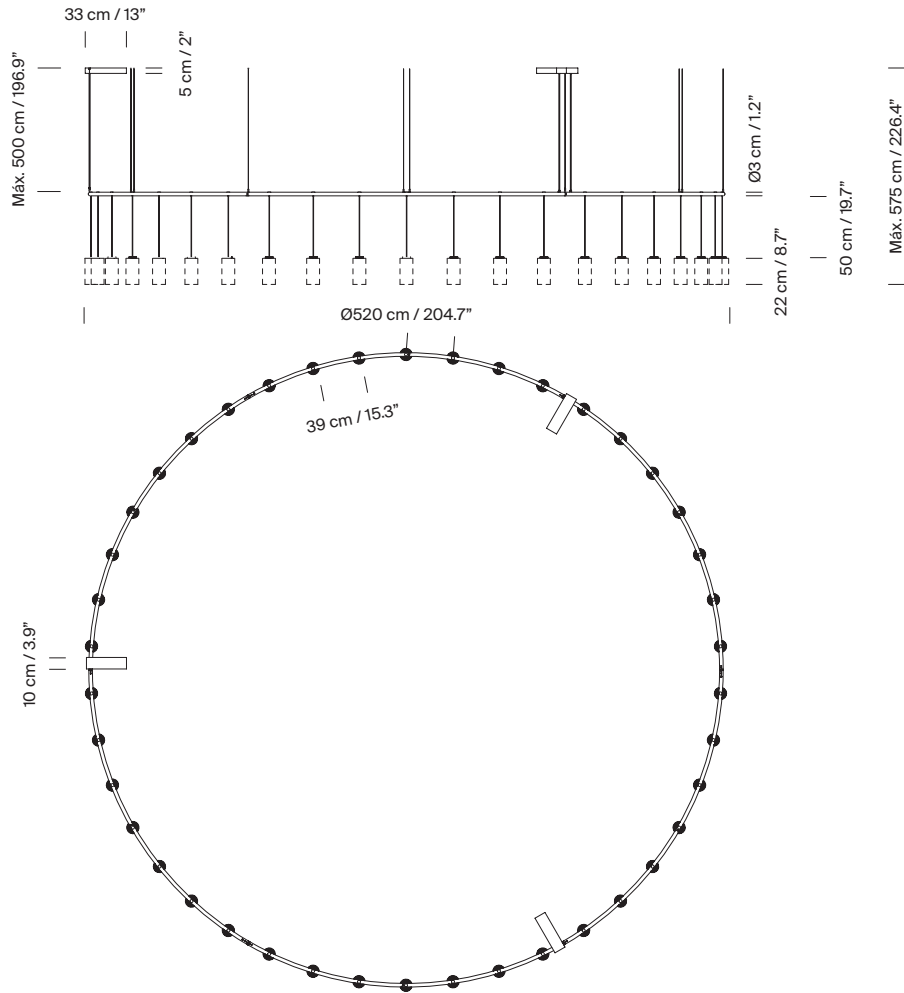

Model D: Cirio Oval

Circular canopy (CE market)

M+A+B

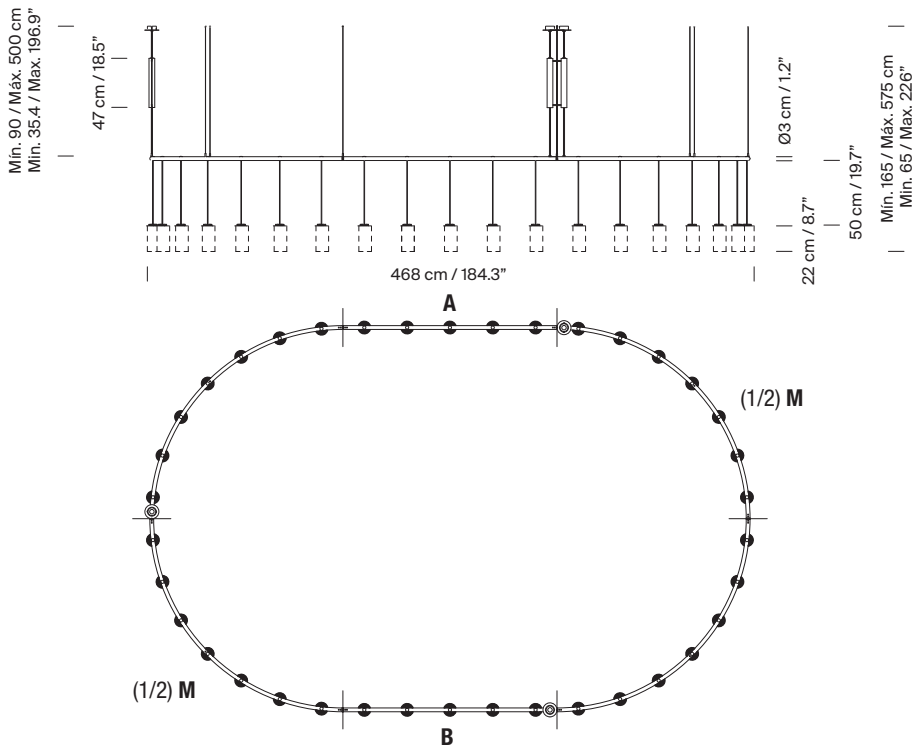

Model D: Cirio Oval

Rectangular canopy

M+A+B

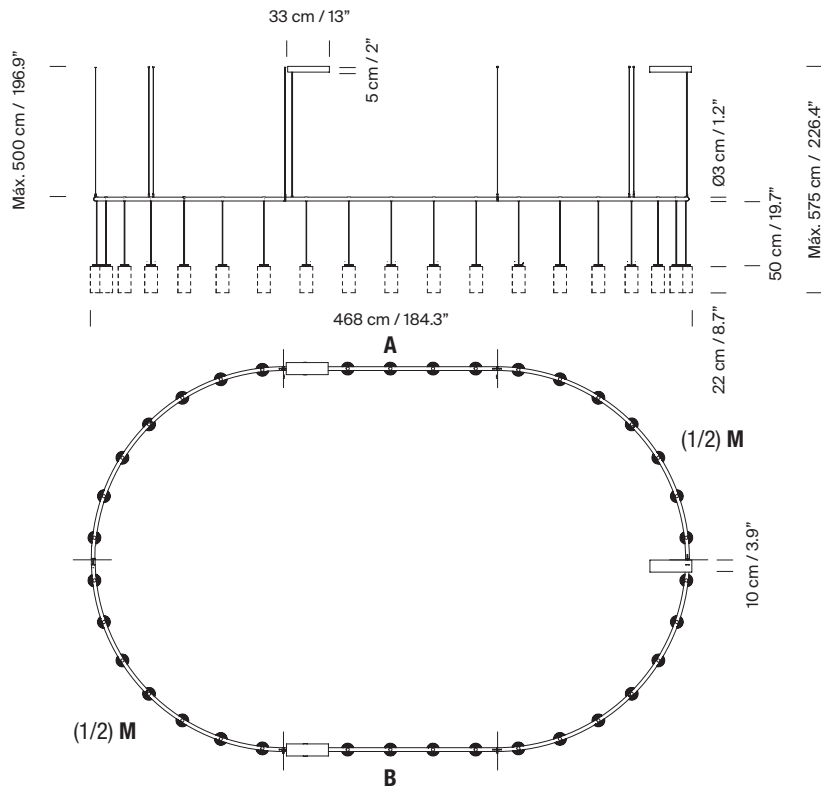

Collection:
 Pendant lamps



Cirio Simple



Cirio Múltiple



Cirio Cascada



Cirio Circular



Cirio Lineal



Cirio Chandelier

Wall lamps



Cirio