

Majestic

by La Mamba



OMELETTE
EDITIONS

Majestic

Información Técnica Technical information

OM MajeB2. Armchair

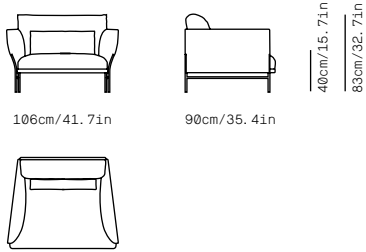

OM MajePF90. Pouf

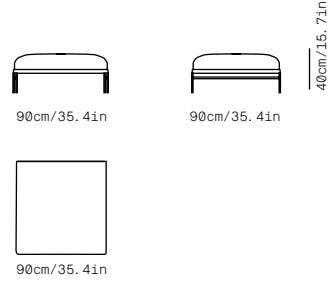

OM MajeS2P. Two seater sofa

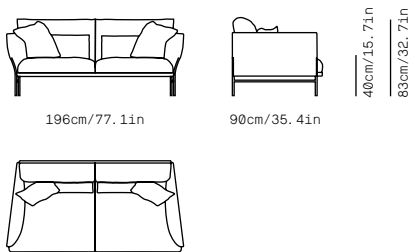

OM MajeS4P. Four seater sofa

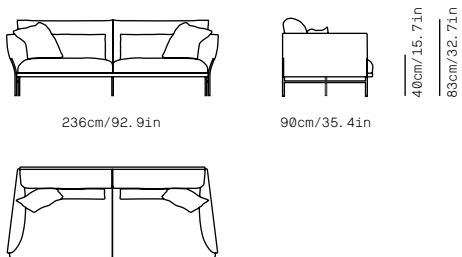

OM MajeS4PXL. XL Four seater sofa

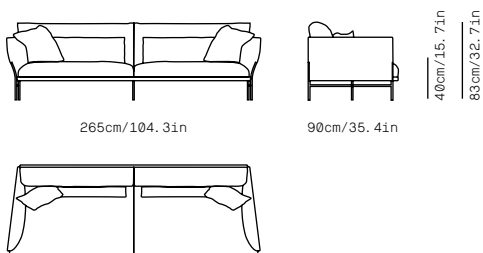

Majestic Modular

Información Técnica Technical information

OM MajeMDB1. Lateral Element

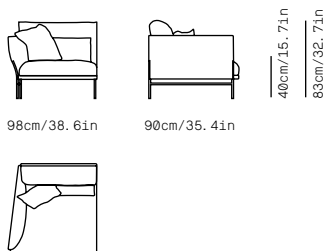

OM MajeMDB2. Lateral Element

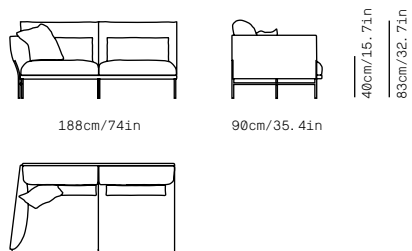

OM MajeMDB3. Lateral Element

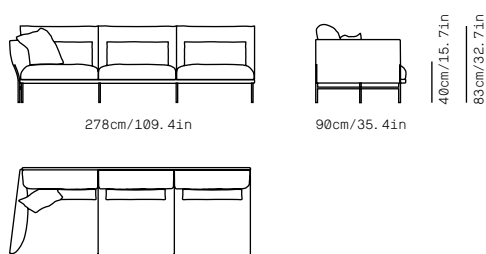

OM MajeMD1. Central Element

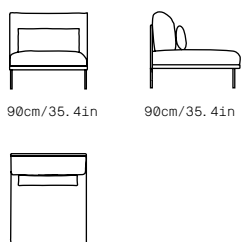

OM MajeMD2. Central Element

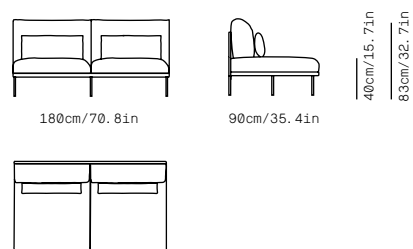

OM MajeMD3. Central Element

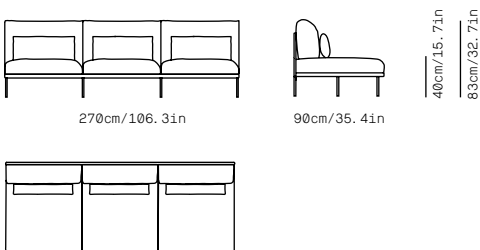

Majestic Modular

Información Técnica
Technical information

OM MajeMP1. Pouf Element

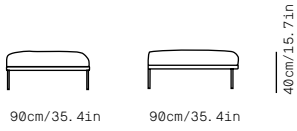

OM MajeCHL1. Chaise Longue

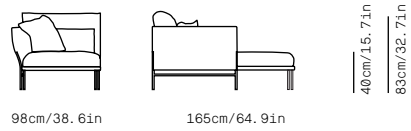

OM MajeRI. Corner Element

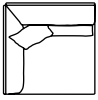
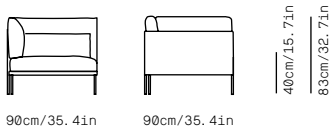

Comp. 01 (MDB2+MDB1)

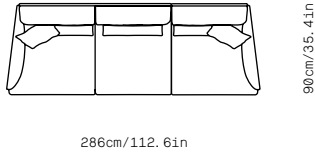

Comp. 02 (MDB2+CHL1)

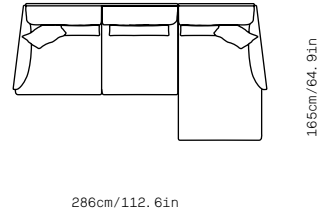

Comp. 03 (MDB2+RI+MDB2)

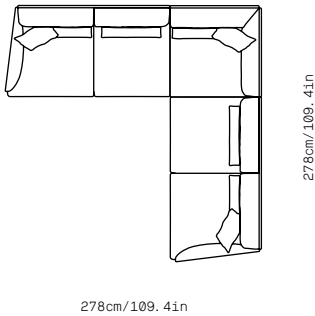

Comp. 04 (MDB2+MD1+RI+MDB2)

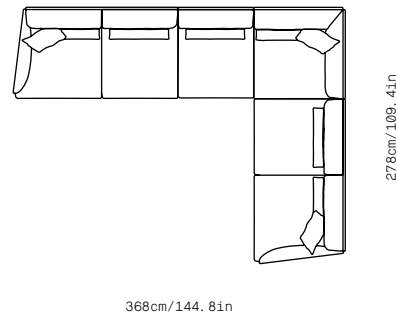

Comp. 05 (MDB2+MD1+RI+MD2+MP1)

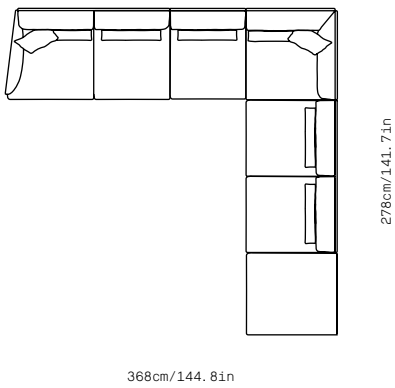

Comp. 06 (MDB2+MD1+RI+MP1+MDB2)

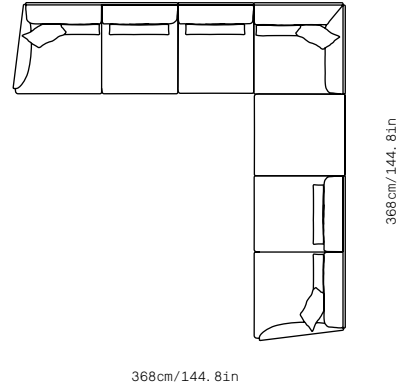

Comp. 07 (CHL1+MD2+MD1+RI+MD2+MP1)

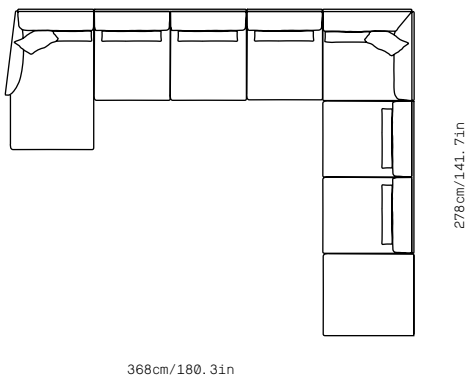

Comp. 08 (MDB2+MD2+RI+MD2+MDB1)

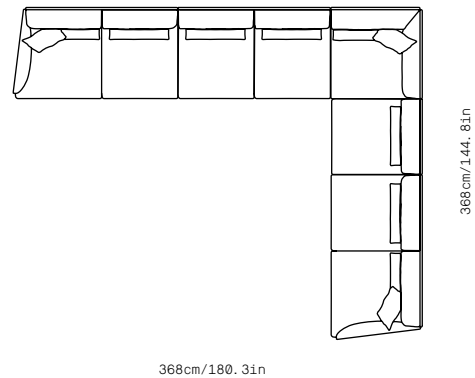

Majestic

Información Técnica Technical information

Patás Legs

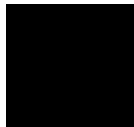

Negro Black
RAL 9005

Estructura de madera de pino Flandes reforzada metalicamente. Pies metálicos termolacados. Suspensión de asiento mediante cinchas elásticas. Cojín de asiento compuesto por espuma de poliuretano libres de CFC, envuelto por edredón de plumas de oca. Cojín de respaldo compuesto por plumas de oca con alma de espuma de poliuretano libre de CFC, cojín riñonera compuesto por plumas de oca. Totalmente desenfundable.

Tejidos Fabric

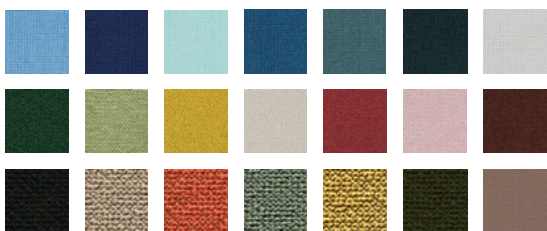

Grupo A / B / C / D / E
Group A / B / C / D / E

Flanders pine wood structure reinforced with metal. Thermo-lacquered metal legs. Elastic webbing chair support. Seat cushion made of CFC-free polyurethane foam, wrapped by a goose down duvet. Backrest cushion made of goose feathers with a CFC-free polyurethane foam core, lumbar cushions made of goose feathers. Totally removable.



OMELETTE
EDITIONS