

## Stone lounge chair

by Stefano Giovannoni & Elisa Gargan

Stones outdoor furniture collection, designed by Stefano Giovannoni, convinces with its organic shapes. As its name suggests it appears to be found in nature itself, creating synergism between the natural and the artificial landscape. Stones can fit perfectly into any environment, transmitting its own particular elegance, thanks to its material, as well as its original shape.



## Info

---

### Description

Made of polyethylene resin by rotational moulding. 100% Recyclable. Item suitable for indoor and outdoor use. Available in different finishes.

Weight: 13 Kg

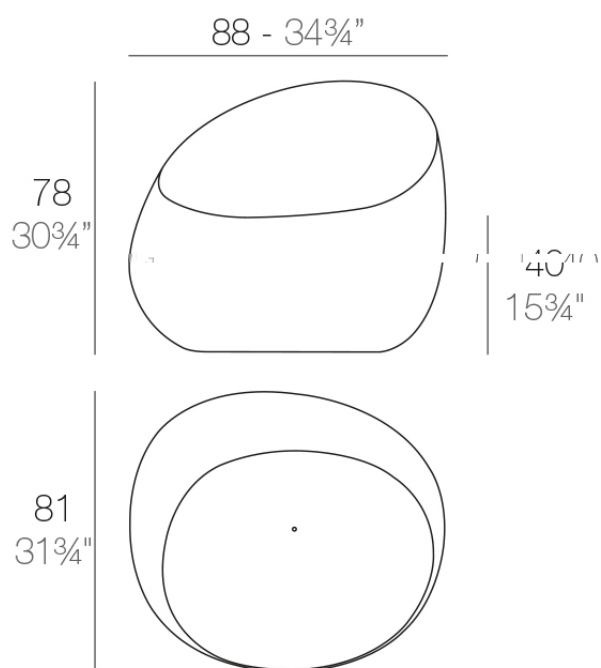

STONE Butaca  
STONE Lounge Chair

## Accessories

---

- Fabric

## Finishes

---

### finishes

---

#### BASIC

Ref. 55006



purjai red

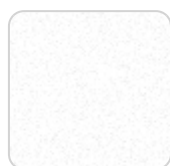

white



black



bronze



steel



anthracite



red



khaki



taupe



ecru



beige

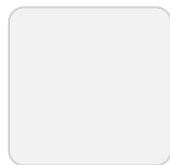

ice



notte blue

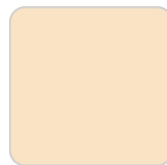

crema

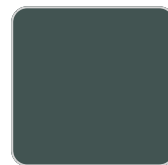

green



orange

#### Matt Polyethylene

#### LACQUERED

Ref. 55006F

# VONDOM



purjai red



modo green



white



black



bronze



steel



anthracite



champany



red



khaki



taupe



ecru



beige

Lacquered Polyethylene

## lighting

---

WHITE LED  
Ref. 55006W



ice

White internally lit unit with LED technology. Available only in matte ice white finish.

RGBW LED  
Ref. 55006L



ice

Unit with internal lighting with RGBW LED technology and remote control unit for switching colors. Available only in matte ice white finish. Remote control included.

## RGBW LED DMX

Ref. 55006D



ice

Unit with internal lighting with RGBW LED technology and remote control unit for switching colors. Also controlled by DMX-1024 (wireless), enabling communication between one or more products simultaneously via the DMX transmitter (not included). There are two options to choose from: Professional XLR DMX and Home WIFI DMX. (Remote control included). Optional battery

## RGBW LED BATTERY

Ref. 55006Y

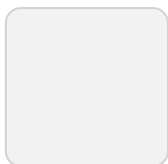

ice

Unit with internal lighting with battery-powered RGBW LED technology. Includes charger and remote control for switching colors and charger. Available only in matte ice white finish.

# VONDOM

RGBW LED DMX BATTERY

Ref. 55006DY

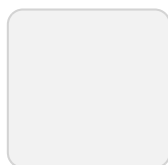

ice

Unit with internal lighting with RGBW LED technology and remote control unit for switching colors. Also controlled by DMX-1024 (wireless), enabling communication between one or more products simultaneously via the DMX transmitter (not included). There are two options to choose from: Professional XLR DMX and Home WIFI DMX. (Remote control included).

## Ambients

---

