

Diagonal Collection

by Yonoh



Like a line, which crosses a space from end to end, the **Diagonal pool table** fills any room with design, elegance and a playful attitude.

info@rs-barcelona.com
rs-barcelona.com

Follow us



Diagonal Indoor Pool Table

rs-barcelona

by Yonoh



Finishes

Structure:

- RAL 9005 TEXTURED
- RAL 9016 TEXTURED
- RAL 3020 TEXTURED
- RAL 5013 TEXTURED
- RAL 6011 TEXTURED

Cloth:

- black
- grey
- natural
- grey blue
- classic green

Legs:

- iroko
- walnut
- oak

Make it yours

Customisation options

Customise your pool table with the RAL colour and cloth* that fit to your project.

And add your logo on the cloth.

* Ask for the colour options

Technical Info

7ft American

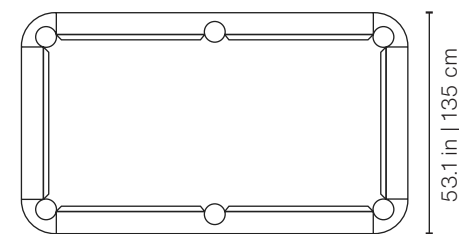
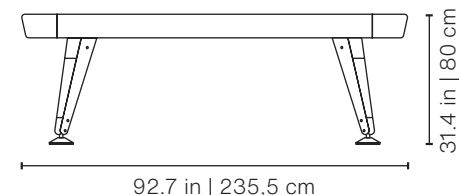

Playing area: 78.7x39.4 in | 200x100 cm

Weight

493.8 lb | 224 kg

Packaging

Dimensions:

98x58x21.6 in | 248x148x55 cm

Weight

639.9 lb | 290 kg

8ft American

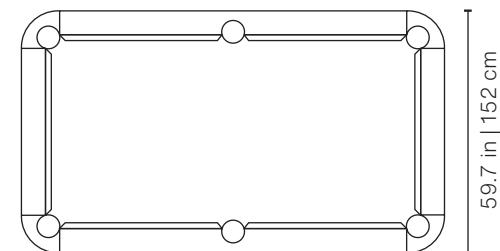
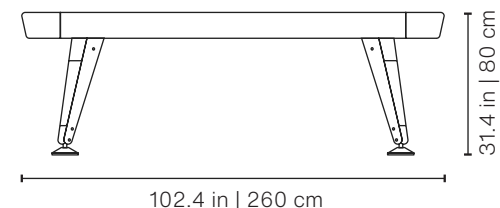

Playing area: 88.2x22.1 in | 224x112 cm

Weight

529 lb | 240 kg

Packaging





Dimensions:

107.1x65x21.6 in | 272x165x55 cm

Weight

705.5 lb | 320 kgj

Diagonal Indoor Pool Table comes with:

-  **16 balls**
Aramith Premium pool set.
-  **2 cues**
Dufferin club cue Canadian Maple.
-  **1 triangle**
-  **12 black chalk**
Master
-  **Table brush**

Materials

Structure: Steel with micro textured polyester paint.

Cloth: Gorina 90% worsted wool and 10% nylon.

Board: 20 mm thickness 1 piece fibre cement.

Legs: Steel with micro textured polyester paint and iroko walnut or oak wood.

Cushion: K66 premium rubber cushion.

Diagonal Outdoor Pool Table

by Yonoh

rs-barcelona



Finishes

Structure:



RAL 9005
TEXTURED



RAL 9016
TEXTURED

Legs:



iroko

Cloth:



black



carbon



natural

The Diagonal board is a compact **fibre cement** slab. **Tougher, lighter** and more **sustainable** than slate. It comes in a **single piece** for **easy assembly**, without the need for a team of professionals, and levelling.

Technical Info

7ft American

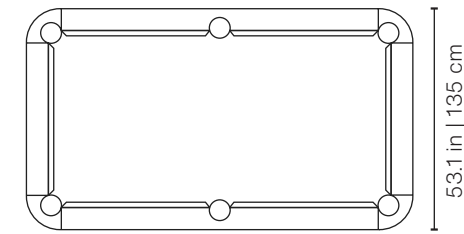
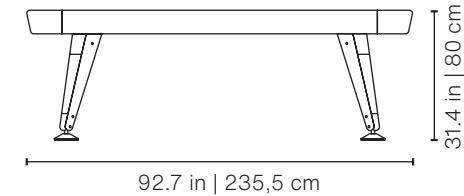

Playing area: 78.7x39.4 in | 200x100 cm

8ft American

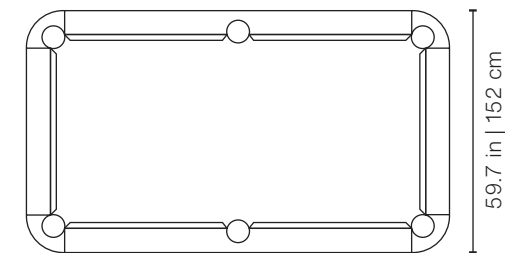
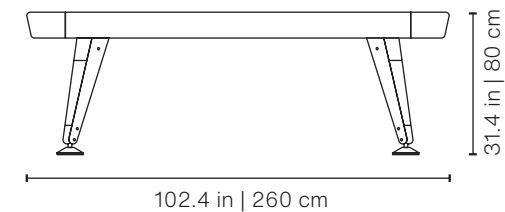

Playing area: 88.2x22.1 in | 224x112 cm

Materials

Structure: Primer coated steel with micro textured polyester paint.

Cloth: Solid from Sunbrella (100% acrylic).

Board: 20 mm thickness 1 piece fibre cement.

Legs: Primer coated steel with micro textured and iroko walnut or oak wood.

Cushion: K66 premium rubber cushion.

Weight

493.8 lb | 224 kg

Packaging

Dimensions:

98x58x21.6 in | 248x148x55 cm

Weight

639.9 lb | 290 kg

Weight

529 lb | 240 kg

Packaging

Dimensions:

107.1x65x21.6 in | 272x165x55 cm

Weight

705.5 lb | 320 kg

Diagonal Indoor Pool Table comes with:



16 balls

Aramith Premium pool set.



2 cues

Dufferin club cue Canadian Maple.



1 triangle



12 black chalk

Master

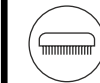

Table brush



Protective cover

Diagonal Indoor Floor Cue Rack

rs-barcelona

by Yonoh



Technical Info

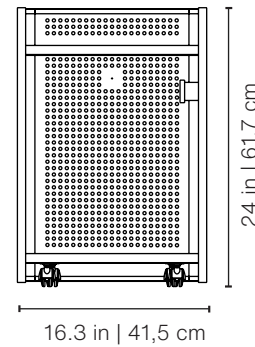

Weight
33 lb | 15 kg

Packaging Dimensions:
18.9x17.3x26.6 in | 48x44x67 cm

Weight
35.3 lb | 16 kg

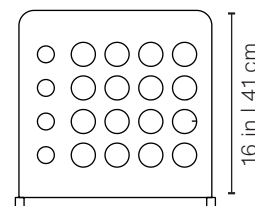

Diagonal Indoor Floor Cue Rack comes with:



Wheels

Balls, cues, black chalk, triangle and brush are included with Diagonal pool tables. Diagonal floor cue rack comes without accessories.

Finishes

Structure:



Wood:

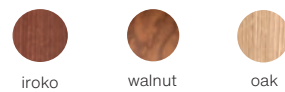

Materials

Structure: Steel finished with a micro textured polyester paint.

Trays: Iroko, walnut or oak

Diagonal Outdoor Floor Cue Rack

by Yonoh

rs-barcelona



Technical Info

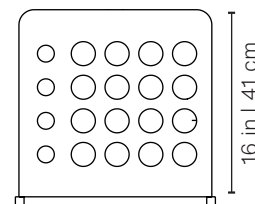
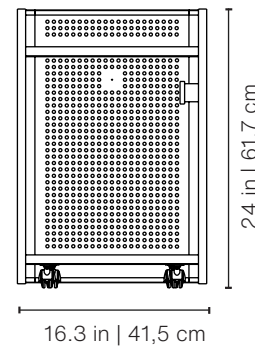



Weight
33 lb | 15 kg

Packaging Dimensions:
18.9x17.3x26.6 in | 48x44x67 cm

Weight
35.3 lb | 16 kg

Finishes

Structure:  RAL 9005 TEXTURED  RAL 9016 TEXTURED

Wood:  iroko

Materials

Structure: Primer coated steel with micro textured polyester paint.

Trays: Fenix (white or black).

Wooden details: Iroko wood.

Diagonal Outdoor Floor Cue Rack comes with:



Balls, cues, black chalk, triangle and brush are included with Diagonal pool tables. Diagonal floor cue rack comes without accessories.

Diagonal Top

by Rafael Rodríguez

rs-barcelona

Indoor



Outdoor



Technical Info

7ft American

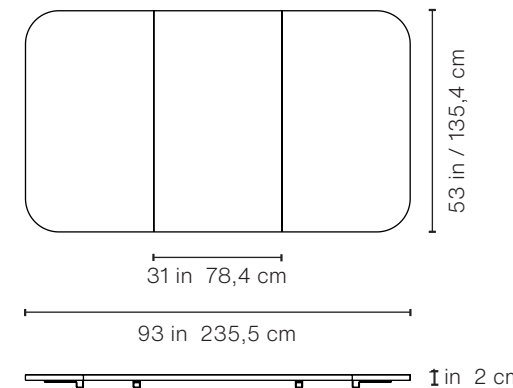

Weight
105.8 lb | 48 kg

Packaging Dimensions:
57.8x35x9.8 in | 147x89x25

Weight
114.6 lb | 55 kg

8ft American

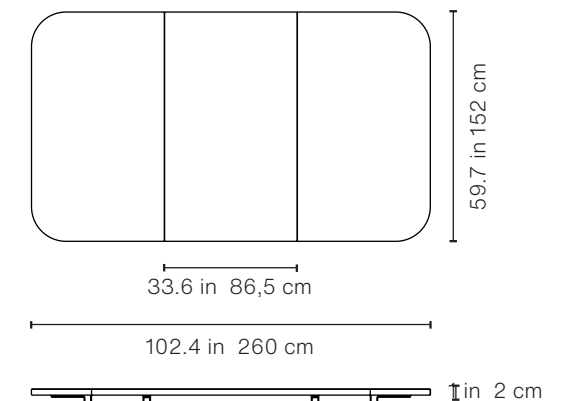

Weight
132.3 lb | 60 kg

Packaging dimensions:
63.4x37.4x10.2 in | 161x95x26 cm

Weight
147.7 lb | 67 kg

Indoor finishes



Outdoor finishes



It comes in 3 spare pieces



Materials

Indoor top: Cross-ply and irko, walnut or oak finish.
Outdoor top: Fenix (white or black).

diagonalinprojects



- Alexandra Hotel | Barcelona (Spain)



- Genialidades office | Barcelona (Spain) -



- Seventy Hotel | Barcelona (Spain) -

diagonalimages



- Diagonal outdoor + Fenix top -



- Diagonal indoor black-walnut -

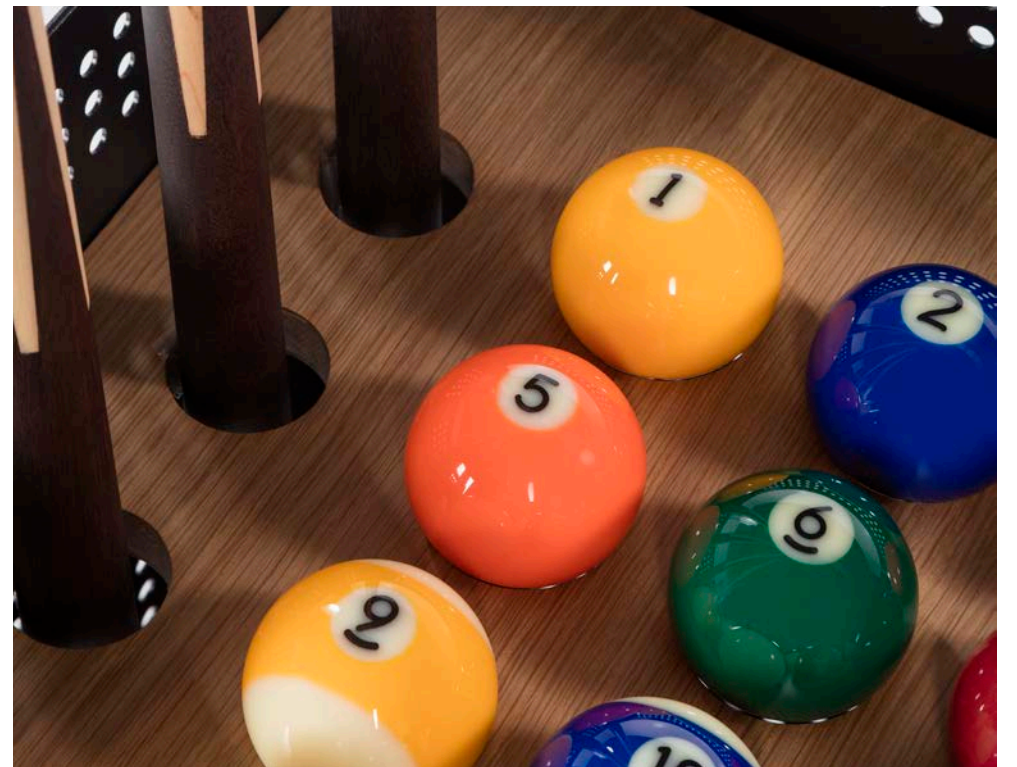

- Diagonal floor cue rack detail -