

systemtronic
datasheet GREEN CLOUD



General description:

The design of this plant pots evokes lamps emitting vegetation.

Designer: Mermelada Estudio.



Technical description:

It includes a saucer.

Material:

- Container: Aluminum.
- Column: Estruded aluminum.
- Base: Steel. Zinc based paint.

Dimensions:

- GREENLIGHT_L: Ø515x1500 mm Ø20.28"x59.06"
- GREENLIGHT_M: Ø440x1140 mm Ø17.32"x44.88"
- GREENLIGHT_S: Ø380x667 mm Ø14.96"x26.26"

systemtronic _ GreenCloud
 www.st-systemtronic.com
 nacional@st-systemtronic.com · export@st-systemtronic.com
 tel. 96-1852784 · fax.34-961854482



For the right use of Green cloud inner plastic plant pots must be included.

GREEN LIGHT_L

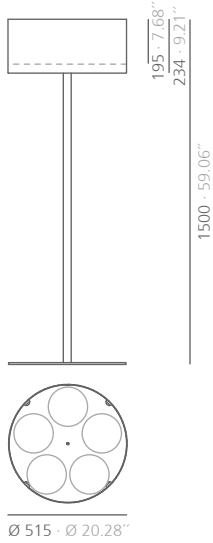

Don't add the soil directly to the Green Cloud.
Must be included: 1 saucer & 5 flower pots of 2,8 litres
Ø 170_h 180
Ø 6.69" _ h 7.09"

GREEN LIGHT_M

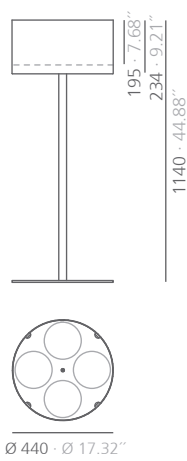

Don't add the soil directly to the Green Cloud.
Must be included: 1 saucer & 4 flower pots of 2,8 litres
Ø 170_h 180
Ø 6.69" _ h 7.09"

GREEN LIGHT_S

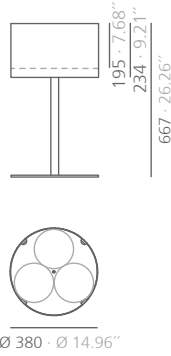

Don't add the soil directly to the Green Cloud.
Must be included: 1 saucer & 3 flower pots of 2,8 litres
Ø 170_h 180
Ø 6.69" _ h 7.09"

GREEN CLOUD_L

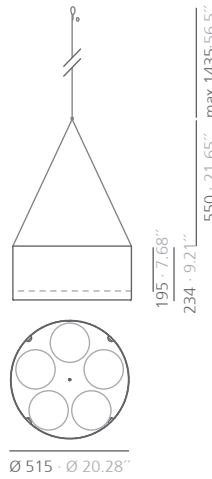

Don't add the soil directly to the Green Cloud.
Must be included: 1 saucer & 5 flower pots of 2,8 litres
Ø 170_h 180
Ø 6.69" _ h 7.09"

GREEN CLOUD_M

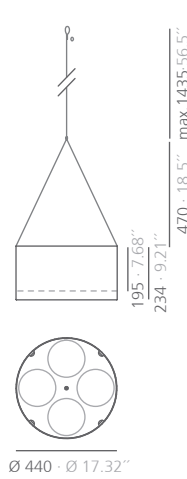

Don't add the soil directly to the Green Cloud.
Must be included: 1 saucer & 4 flower pots of 2,8 litres
Ø 170_h 180
Ø 6.69" _ h 7.09"

GREEN CLOUD_S

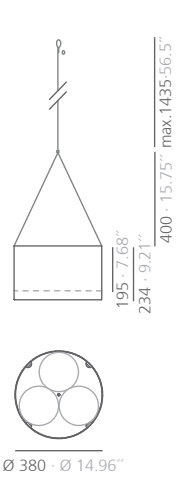

Don't add the soil directly to the Green Cloud.
Must be included: 1 saucer & 3 flower pots of 2,8 litres
Ø 170_h 180
Ø 6.69" _ h 7.09"

GREEN CLOUD PEG_L

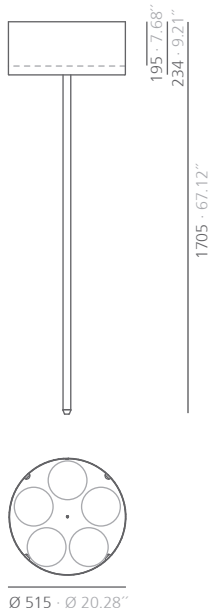

Don't add the soil directly to the Green Cloud.
Must be included: 1 saucer & 5 flower pots of 2,8 litres
Ø 170_h 180
Ø 6.69" _ h 7.09"

GREEN CLOUD PEG_M

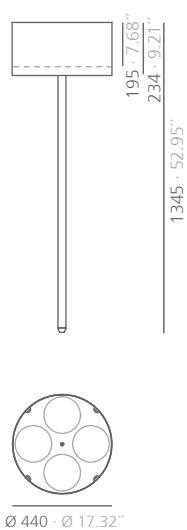

Don't add the soil directly to the Green Cloud.
Must be included: 1 saucer & 4 flower pots of 2,8 litres
Ø 170_h 180
Ø 6.69" _ h 7.09"

GREEN CLOUD PEG_S

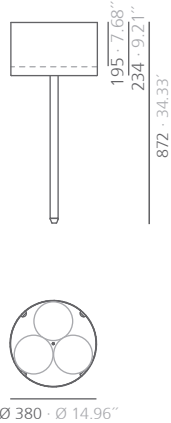

Don't add the soil directly to the Green Cloud.
Must be included: 1 saucer & 3 flower pots of 2,8 litres
Ø 170_h 180
Ø 6.69" _ h 7.09"

mm · inches

Finishes:

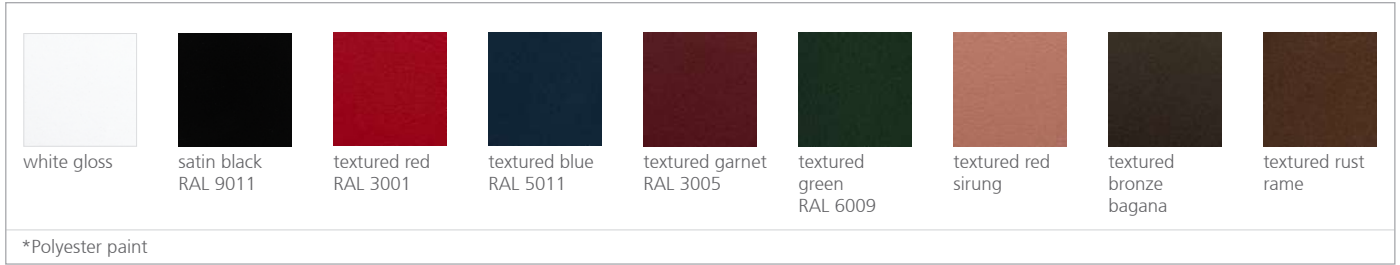

Consult for special dimensions or any other modification.

Maintenance:

-Polyester Paint:

For dry dirt (dust), use a damp cloth. For greasy/oily stains (fingerprints), wipe with a sponge with water and dishwashing liquid. Rinse with a damp cloth. Avoid using products containing solvents and/or pure ethyl alcohol.

-Aluminium-metal-glass-melamine-plastic:

We recommend using normal cleaning products for delicate surfaces. Alcohol, solvents and abrasive agents must be avoided.

Sustainability:

Manufacturing materials are 100% recyclable. The used paints do not contain solvents, do not consume water and do not generate emissions or waste. The result is a lower environmental impact.

Assembly for Green Cloud hanging

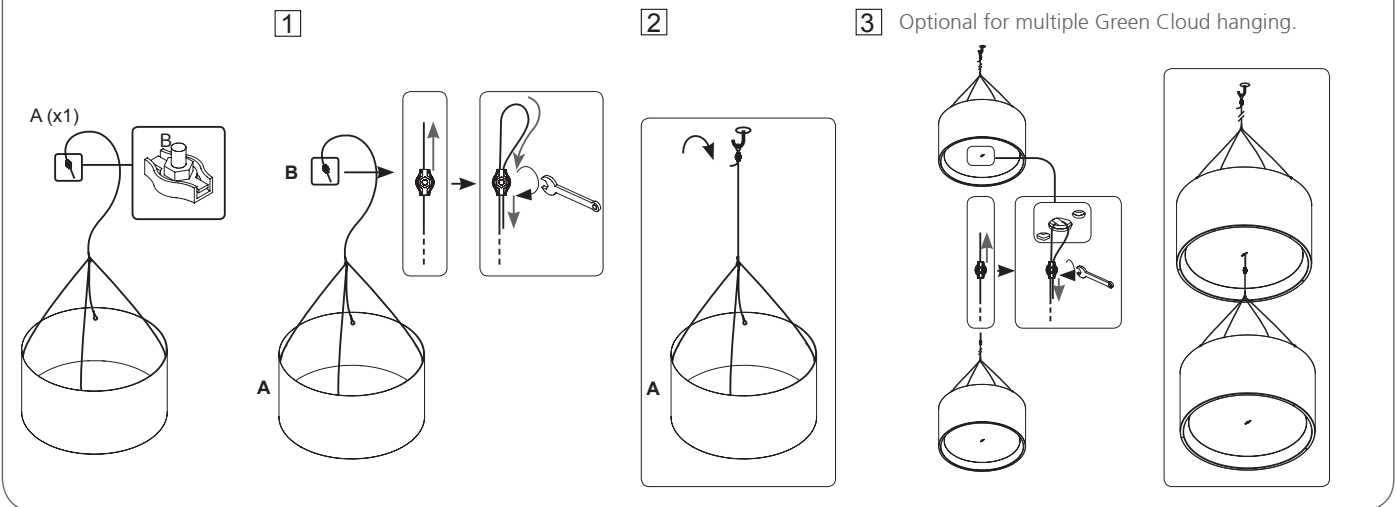

Assembly for Green Cloud standing

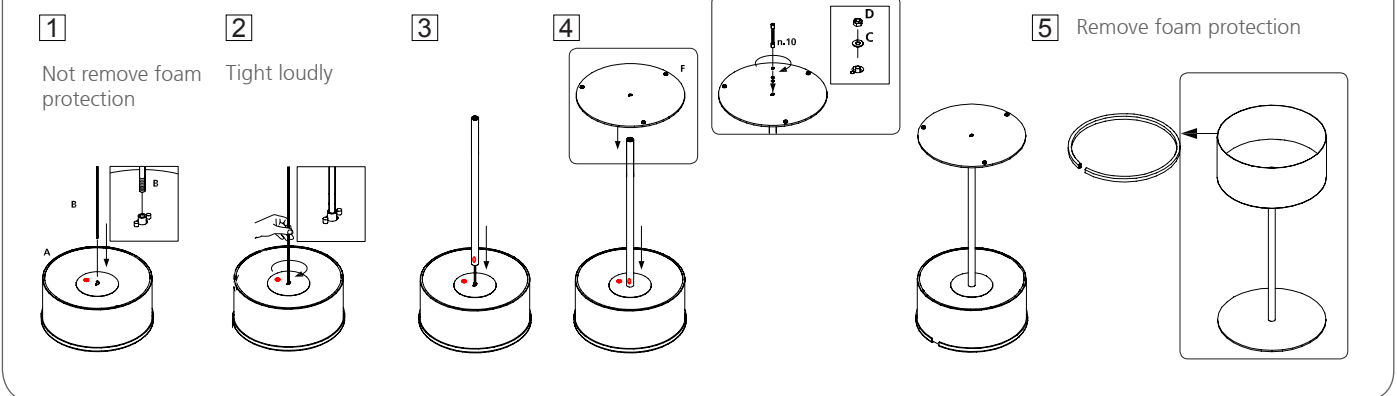

systemtronic _ GreenCloud

www.st-systemtronic.com

nacional@st-systemtronic.com · export@st-systemtronic.com

tel. 96-1852784 · fax.34-961854482

ASSOCIATED N°00320

BAIDIMME®
INSTITUTO TECNOLÓGICO

METALÚRGICO, MUEBLE, MADERA, EMBALAJE Y AFINES



Calidad Controlada

Assembly for Green Cloud Peg

- 1 Lay on the floor on the foam protection.

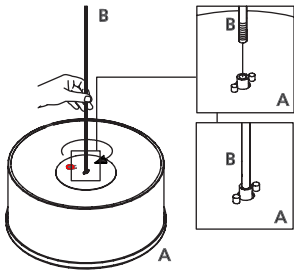

- 2 Place the column by matching the stickers.

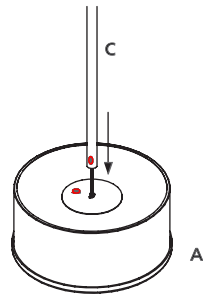

- 3 Screw and tighten the end piece of the plant pot with a fixed wrench.

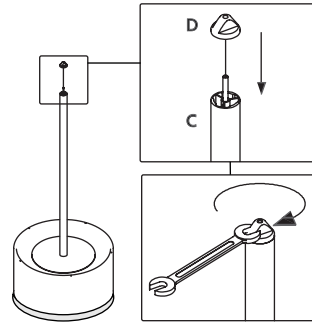

- 4 Make a hole in the floor, recommended Ø35mm diameter. Minimum depth of 200mm depending on the type of soil.

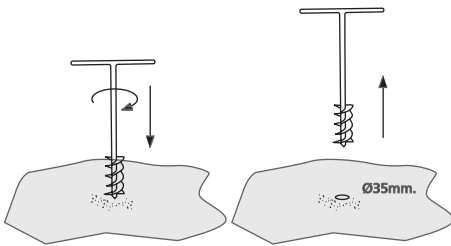

- 5 Place the plant pot in the hole.

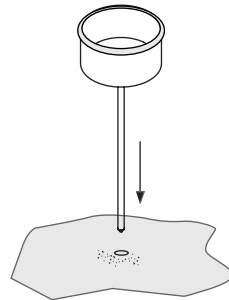

- 6 Remove foam protection.

