



Maarten Chair

BY VICTOR CARRASCO

Maarten Chair

2012, BY VICTOR CARRASCO

CHAIRS AND STOOLS

The powder coated steel tube structure and the carefully made, elegant, upholstered seat of the Maarten chair recall the classics of the '70s. Maarten is available in a wide variety of base and seat finishes to fit with all kind of environments. Fixed upholstery covering available in the soft and smooth versions.

Plastic chairs with four metal legs or sled base can be stacked up to 10 units and up to 4 units for the upholstered chairs. We do not recommend stacking upholstered chairs for long periods of time as it can damage the upholstery.

HIGH BACKREST SEAT OPTIONS

Plastic

Injected polypropylene seat in white, black, taupe, dusty green, yellow ochre or brick.

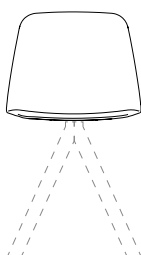

Plastic with cushion

Injected polypropylene seat in white, black, taupe, dusty green, yellow ochre or brick with upholstered seat cushion.

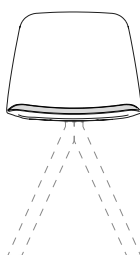

Smooth upholstery

Injected polypropylene seat with smooth upholstery.

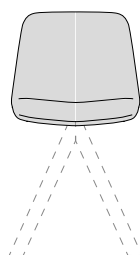

Soft upholstery

Injected polypropylene seat with soft upholstery.

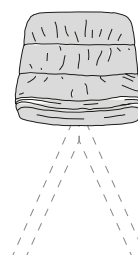

LOW BACKREST SEAT OPTIONS*

Plastic

Injected polypropylene seat in white, black, taupe, dusty green, yellow ochre or brick.

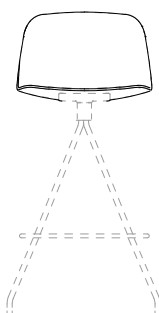

Smooth upholstery

Injected polypropylene seat with smooth upholstery in the finishes of our collection.

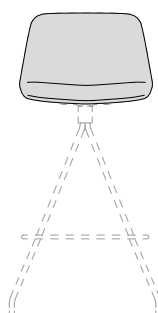

Soft upholstery

Injected polypropylene seat with soft upholstery in the finishes of our collection.

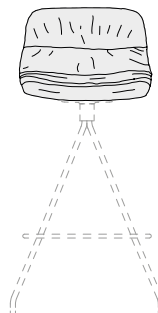

*Only available for stools.



CHAIRS AND STOOLS

CHAIR BASE OPTIONS

Four metal legs

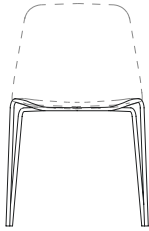
Calibrated steel structure powder coated in thermoreinforced polyester in white, black, taupe or fluorescent orange. Black or white plastic glides with or without felt.





 x10 Plastic versions stackable up to 10 units
 x4 Upholstered versions stackable up to 4 units

Sled

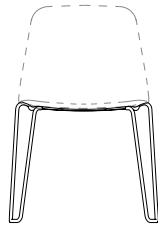
Calibrated steel structure powder coated in thermoreinforced polyester in white, or black. Black or white plastic glides.



 x10 Plastic versions stackable up to 10 units
 x4 Upholstered versions stackable up to 4 units

Swivel

Calibrated steel swivel structure powder coated in thermoreinforced polyester in white, black, taupe or fluorescent orange. Clear polypropylene injection glides.

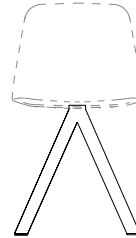

Pyramid swivel

Injected swivel aluminium base powder coated in thermoreinforced polyester in black or white microtexturized. Black or white plastic glides.

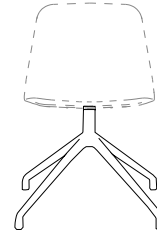

Pyramid swivel with casters

Injected swivel aluminium base powder coated in thermoreinforced polyester in black or white microtexturized with black or white casters for soft floors.

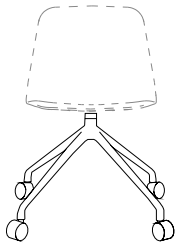

Five casters

Aluminum swivel base powder coated in black or white (high gloss), height adjustment system and black or white casters for soft floors*.

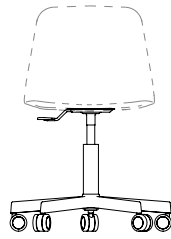

*6 weeks production time.

Flat swivel

Injected swivel aluminium base powder coated in thermoreinforced polyester in black or white microtexturized. Black or translucent plastic glides.

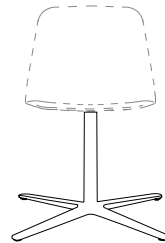

Wooden swivel

Calibrated steel swivel structure finished with oak veneer stained with the finishes of our collection. Clear polypropylene injection glides.

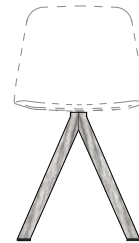

Four wooden legs

Four solid oak wood legs stained with the finishes of our collection. Plastic glides with or without felt.

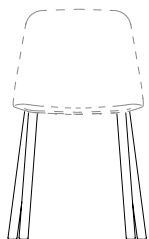

Four upholstered legs

Four solid oak wood legs upholstered with leather or ecoleather. Plastic glides with or without felt.

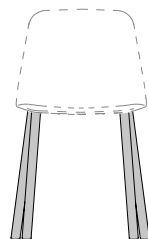

Upholstered swivel

Calibrated steel swivel structure upholstered with leather or ecoleather. Clear polypropylene injection glides.

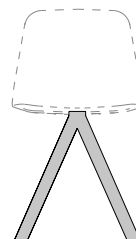

Maarten Chair

2012, BY VICTOR CARRASCO

CHAIRS AND STOOLS

STOOL BASE OPTIONS

Sled counter stool

Calibrated steel structure and footrest powder coated in thermoreinforced polyester in white, or black.
Black or white plastic glides.

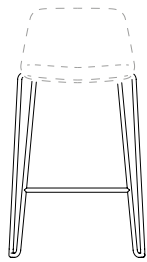

x4 Upholstered versions stackable up to 4 units

Sled bar stool

Calibrated steel structure and footrest powder coated in thermoreinforced polyester in white, or black.
Black or white plastic glides.

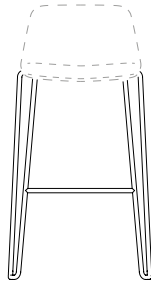

x4 Upholstered versions stackable up to 4 units

Swivel counter stool

Calibrated steel swivel structure and footrest powder coated in thermoreinforced polyester in white, black, taupe or fluorescent orange.
Black or white plastic glides with or without felt.

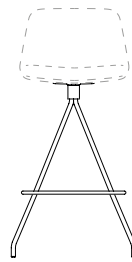

Swivel bar stool

Calibrated steel swivel structure and footrest powder coated in thermoreinforced polyester in white, black, taupe or fluorescent orange.
Black or white plastic glides with or without felt.

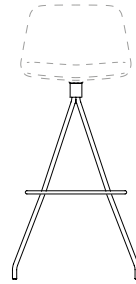

Four wooden legs counter stool

Four solid oak wood legs stained with the finishes for our collection.
Calibrated steel footrest powder coated in black thermoreinforced polyester.
Plastic glides with or without felt.

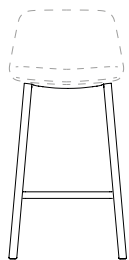

Four wooden legs bar stool

Four solid oak wood legs stained with the finishes for our collection.
Calibrated steel footrest powder coated in black thermoreinforced polyester.
Plastic glides with or without felt.

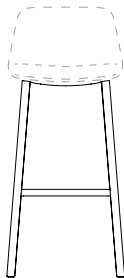

CHAIRS AND STOOLS

AUDITORIUM SEAT OPTIONS

Plastic

Injected polypropylene seat in white, black, taupe, dusty green, yellow ochre or brick. Screws or anchoring system not included.



Plastic with cushion

Injected polypropylene seat in white, black, taupe, dusty green, yellow ochre or brick and seat cushion. Screws or anchoring system not included.



Smooth upholstery

Injected polypropylene seat in smooth upholstery. Screws or anchoring system not included.

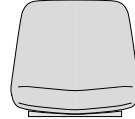

Soft upholstery

Injected polypropylene seat in soft upholstery. Screws or anchoring system not included.



ARMREST OPTIONS

Armrest

Calibrated steel armrest powder coated in thermoreinforced polyester in black, white, taupe or fluorescent orange. Available for all bases and seats but the auditorium base. Not available for low backrest stools.

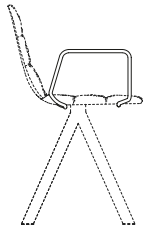

Wooden armrest

Calibrated steel armrest powder coated in thermoreinforced polyester in black, white, taupe or fluorescent orange, with natural oak armrests stained with the finishes of our collection. Available for all bases and seats but the auditorium base. Not available for low backrest stools.

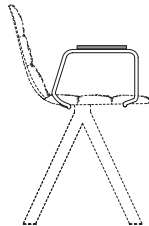

Upholstered armrest

Calibrated steel armrest powder coated in thermoreinforced polyester in black, white, taupe or fluorescent orange and upholstered with leather or ecoleather armrest. Available for all bases and seats but the auditorium base. Not available for low backrest stools.

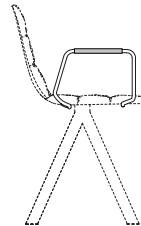

ACCESORIOS

Side table

HPL sidetable with aluminum mechanism and anti-panic system. Left or right versions. Available only for four metal legs base.

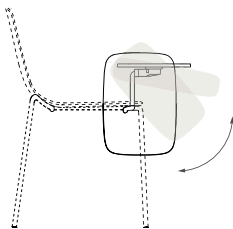

Maarten Chair

2012, BY VICTOR CARRASCO

CHAIRS AND STOOLS

Test certificates: ANSI BIFMA X5.4:2012 and UNE-EN 16139:2013vc2015

Calibrated steel structure powder coated in thermoreinforced polyester in white, black, taupe or fluorescent orange. Black or white plastic glides with or without felt.*

Needed fabric for material:

1.40 m wide:

Cushion: 0.7 m

FOUR METAL LEGS BASE

Plastic

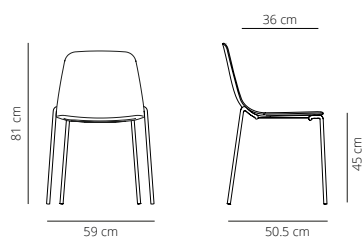

15 kg
(x1) 61x61x99 cm (0.37 m³)

x10 Stackable up to 10 units.

Minimum order 2 units.



See the full list of products on page 8

CODE	FINISHES	
	STRUCTURE	SEAT
MAAPL4P	white, black	white, black, taupe, dusty green, yellow ochre or brick
	taupe or fluorescent orange	white, black, taupe, dusty green, yellow ochre or brick

NOTE: Price per unit.

NOTE: The package contains 2 units.

Plastic with cushion

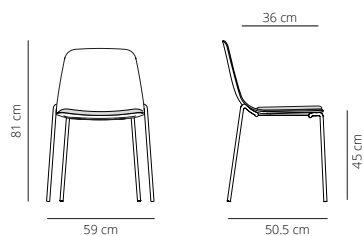

15 kg
(x1) 61x61x99 cm (0.37 m³)

x4 Stackable up to 4 units.

CODE	FINISHES		
	STRUCTURE	SEAT	UPHOLSTERY
MAAPL4PC-1	white, black	white, black, taupe, dusty green, yellow ochre or brick	G1 (COM/COL)
MAAPL4PC-2			G2
MAAPL4PC-3			G3
MAAPL4PC-4			G4
MAAPL4PC-5			G5
MAAPL4PC-2			ECOALF
MAAPL4PC-1	taupe or fluorescent orange	white, black, taupe, dusty green, yellow ochre or brick	G1 (COM/COL)
MAAPL4PC-2			G2
MAAPL4PC-3			G3
MAAPL4PC-4			G4
MAAPL4PC-5			G5
MAAPL4PC-2			ECOALF

Maarten Chair

2012, BY VICTOR CARRASCO

Needed fabric for material:
 1.40 m wide:
 Smooth upholstery: 1.1 m
 Soft upholstery: 1.1 m

Smooth upholstery

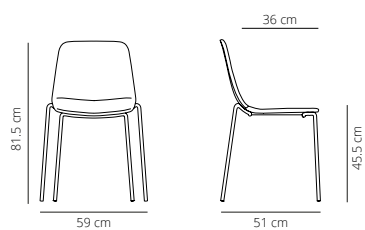

10 kg
 (x1) 58x54x88 cm (0.28 m³)

x4 Stackable up to 4 units.

CODE	FINISHES	
	STRUCTURE	UPHOLSTERY
MAAL4P-1	white, black	G1 (COM/COL)
MAAL4P-2		G2
MAAL4P-3		G3
MAAL4P-4		G4
MAAL4P-5		G5
MAAL4P-2		ECOALF
MAAL4P-1	taupe or fluorescent orange	G1 (COM/COL)
MAAL4P-2		G2
MAAL4P-3		G3
MAAL4P-4		G4
MAAL4P-5		G5
MAAL4P-2		ECOALF

Soft upholstery

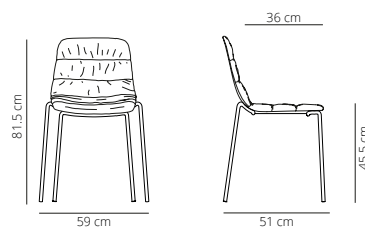

13 kg
 (x1) 58x54x88 cm (0.28 m³)

x4 Stackable up to 4 units.

CODE	FINISHES	
	STRUCTURE	UPHOLSTERY
MAA4P-1	white, black	G1 (COM/COL)
MAA4P-2		G2
MAA4P-3		G3
MAA4P-4		G4
MAA4P-5		G5
MAA4P-2		ECOALF
MAA4P-1	taupe or fluorescent orange	G1 (COM/COL)
MAA4P-2		G2
MAA4P-3		G3
MAA4P-4		G4
MAA4P-5		G5
MAA4P-2		ECOALF

Maarten Chair

2012, BY VICTOR CARRASCO

CHAIRS AND STOOLS

Certificado de ensayo: ANSI BIFMA X5.4:2012 and UNE-EN 16139:2013vc2015
 Calibrated steel structure powder coated in thermoreinforced polyester in white, or black. Black or white plastic glides.

Needed fabric for material:
 1.40 m wide:
 Cushion: 0.7 m

SLED BASE

Plastic

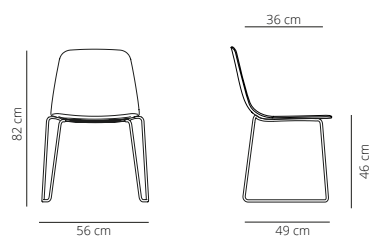

22 kg
 (x1) 61x61x99cm (0.37 m³)

x10 Stackable up to 10 units.
 x2 Minimum order 2 units.



See the full list of products on page 8

CODE	FINISHES	
	STRUCTURE	SEAT
MAAPLPT	white, black	white, black, taupe, dusty green, yellow ochre or brick

NOTE: Price per unit.
 NOTE: The package contains 2 units.

Plastic with cushion

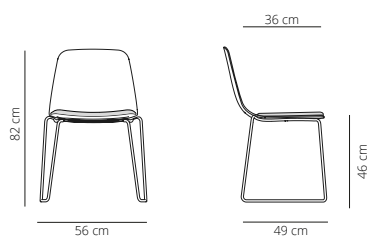

10.3 kg
 (x1) 62x55x88 cm (0.30 m³)

x4 Stackable up to 4 units.

CODE	FINISHES		
	STRUCTURE	SEAT	UPHOLSTERY
MAAPLPTC-1	white, black	white, black, taupe, dusty green, yellow ochre or brick	G1 (COM/COL)
MAAPLPTC-2			G2
MAAPLPTC-3			G3
MAAPLPTC-4			G4
MAAPLPTC-5			G5
MAAPLPTC-2			ECOALF

CHAIRS AND STOOLS



Maarten Chair

2012, BY VICTOR CARRASCO

Needed fabric for material:
1.40 m wide:
Smooth upholstery: 1.1 m
Soft upholstery: 1.1 m

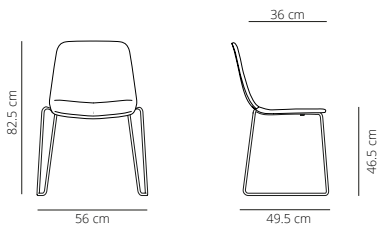
Smooth upholstery





-  9.2 kg
-  (x1) 58x54x88 cm (0.28 m³)
-  x4 Stackable up to 4 units.

CODE	FINISHES	
	STRUCTURE	UPHOLSTERY
MAALPT-1	white, black	G1 (COM/COL)
MAALPT-2		G2
MAALPT-3		G3
MAALPT-4		G4
MAALPT-5		G5
MAALPT-2		ECOALF

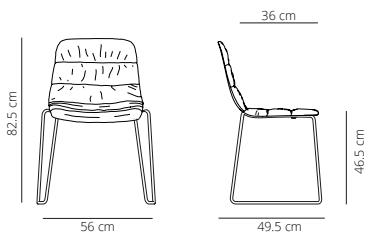
Soft upholstery



-  9.2 kg
-  (x1) 58x54x88 cm (0.28 m³)
-  x4 Stackable up to 4 units.

CODE	FINISHES	
	STRUCTURE	UPHOLSTERY
MAAPT-1	white, black	G1 (COM/COL)
MAAPT-2		G2
MAAPT-3		G3
MAAPT-4		G4
MAAPT-5		G5
MAAPT-2		ECOALF

Maarten Chair

2012, BY VICTOR CARRASCO

CHAIRS AND STOOLS

Four solid oak wood legs stained with the finishes of our collection.
Plastic glides with or without felt.*

Needed fabric for material:
1.40 m wide:
Cushion: 0.7 m

FOUR WOODEN LEGS BASE

Plastic

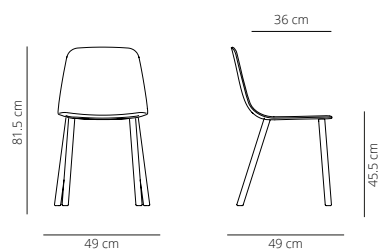

7.3 kg
(x1) 55x55x88 cm (0.27 m³)

CODE	FINISHES	
	STRUCTURE	SEAT
MAAPL4PM	matt oak, cognac, ash or wenge	white, black, taupe, dusty green, yellow ochre or brick

Plastic with cushion

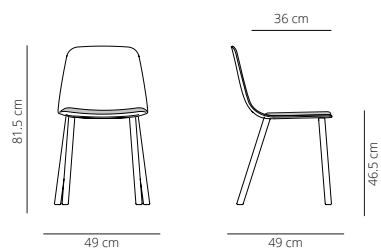

8.4 kg
(x1) 55x55x88 cm (0.27 m³)

CODE	FINISHES		
	STRUCTURE	SEAT	UPHOLSTERY
MAAPL4PMC-1	matt oak, cognac, ash or wenge	white, black, taupe, dusty green, yellow ochre or brick	G1 (COM/COL)
MAAPL4PMC-2			G2
MAAPL4PMC-3			G3
MAAPL4PMC-4			G4
MAAPL4PMC-5			G5
MAAPL4PMC-2			ECOALF

CHAIRS AND STOOLS

Maarten Chair

2012, BY VICTOR CARRASCO

Needed fabric for material:
 1.40 m wide:
 Smooth upholstery: 1.1 m
 Soft upholstery: 1.1 m

Smooth upholstery

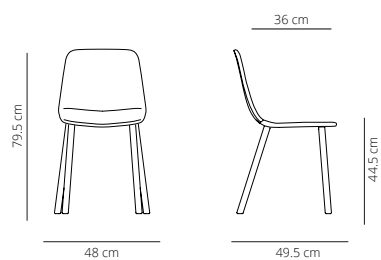

8.3 kg

(x1) 55x55x88 cm (0.27 m³)

CODE	FINISHES	
	STRUCTURE	UPHOLSTERY
MAAL4PM-1	matt oak, cognac, ash or wenge	G1 (COM/COL)
MAAL4PM-2		G2
MAAL4PM-3		G3
MAAL4PM-4		G4
MAAL4PM-5		G5
MAAL4PM-2		ECOALF

Soft upholstery

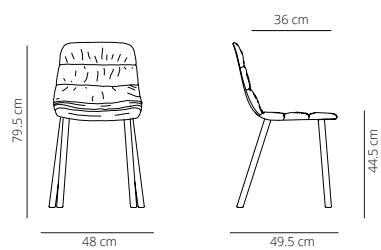

8.6 kg

(x1) 55x55x88 cm (0.27 m³)

CODE	FINISHES	
	STRUCTURE	UPHOLSTERY
MAA4PM-1	matt oak, cognac, ash or wenge	G1 (COM/COL)
MAA4PM-2		G2
MAA4PM-3		G3
MAA4PM-4		G4
MAA4PM-5		G5
MAA4PM-2		ECOALF

Maarten Chair

2012, BY VICTOR CARRASCO

CHAIRS AND STOOLS

Test certificates: UNE-EN 16139:2013vc2015 (only without armrest)

Needed fabric for material:
1.40 m wide:
Cushion: 0.7 m

Calibrated steel swivel structure powder coated in thermoreinforced polyester in white, black, taupe or fluorescent orange. Clear polypropylene injection glides.

SWIVEL BASE

Plastic

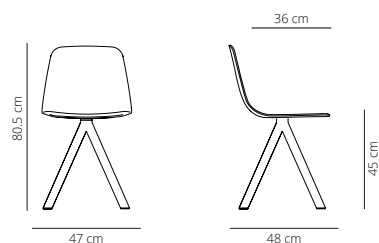

9.9 kg
(x1) 52x52x84cm (0.23 m³)

CODE	FINISHES	
	STRUCTURE	SEAT
MAAPL	white, black	white, black, taupe, dusty green, yellow ochre or brick
	taupe or fluorescent orange	white, black, taupe, dusty green, yellow ochre or brick

Plastic with cushion

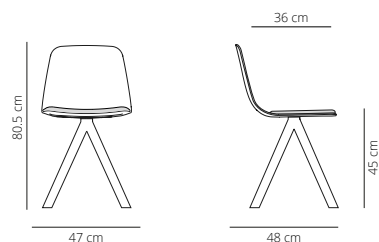

12.1 kg
(x1) 52x52x84 cm (0.23 m³)

CODE	FINISHES		
	STRUCTURE	SEAT	UPHOLSTERY
MAAPLC-1	white, black	white, black, taupe, dusty green, yellow ochre or brick	G1 (COM/COL)
MAAPLC-2			G2
MAAPLC-3			G3
MAAPLC-4			G4
MAAPLC-5			G5
MAAPLC-2			ECOALF
MAAPLC-1	taupe or fluorescent orange	white, black, taupe, dusty green, yellow ochre or brick	G1 (COM/COL)
MAAPLC-2			G2
MAAPLC-3			G3
MAAPLC-4			G4
MAAPLC-5			G5
MAAPLC-2			ECOALF

Maarten Chair

2012, BY VICTOR CARRASCO

Needed fabric for material:
 1.40 m wide:
Smooth upholstery: 1.1 m
Soft upholstery: 1.1 m

Smooth upholstery

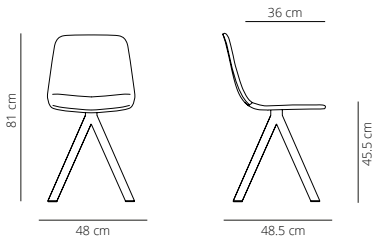

10.2 kg
 (x1) 52x52x84cm (0.23 m³)

CODE	FINISHES	
	STRUCTURE	UPHOLSTERY
MAAL-1	white, black	G1 (COM/COL)
MAAL-2		G2
MAAL-3		G3
MAAL-4		G4
MAAL-5		G5
MAAL-2		ECOALF
MAAL-1	taupe or fluorescent orange	G1 (COM/COL)
MAAL-2		G2
MAAL-3		G3
MAAL-4		G4
MAAL-5		G5
MAAL-2		ECOALF

Soft upholstery

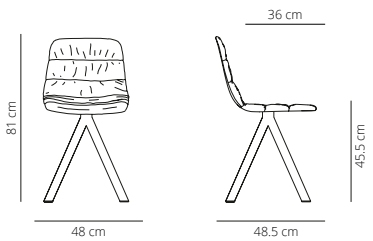

10.2 kg
 (x1) 52x52x84cm (0.23 m³)

QUICK EXPEDITION
15
 BUSINESS DAYS

See the full list of products on page 10

CODE	FINISHES	
	STRUCTURE	UPHOLSTERY
MAA-1	white, black	G1 (COM/COL)
MAA-2		G2
MAA-3		G3
MAA-4		G4
MAA-5		G5
MAA-2		ECOALF
MAA-1	taupe or fluorescent orange	G1 (COM/COL)
MAA-2		G2
MAA-3		G3
MAA-4		G4
MAA-5		G5
MAA-2		ECOALF

Maarten Chair

2012, BY VICTOR CARRASCO

CHAIRS AND STOOLS

Test certificates: UNE-EN 16139:2013vc2015 (only without armrest)

Needed fabric for material:
1.40 m wide:
Cushion: 0.7 m

Injected swivel aluminium base powder coated in thermoreinforced polyester in black or white microtexturized. Black or translucent plastic glides.

PYRAMID SWIVEL BASE

Plastico

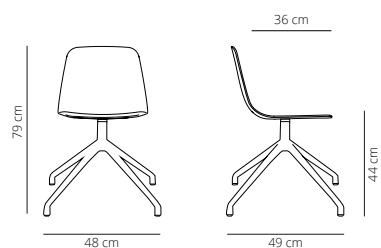

9.3 kg
(x1) 52x52x84cm (0.23 m³)

CODE	FINISHES	
	STRUCTURE	SEAT
MAAPLPI	white, black (microtexturized)	white, black, taupe, dusty green, yellow ochre or brick

Plastic with cushion

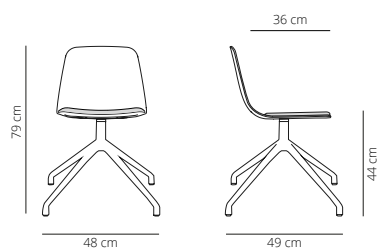

11.5 kg
(x1) 52x52x84 cm (0.23 m³)

CODE	FINISHES		
	STRUCTURE	SEAT	UPHOLSTERY
MAAPLIC-1	white, black (microtexturized)	white, black, taupe, dusty green, yellow ochre or brick	G1 (COM/COL)
MAAPLIC-2			G2
MAAPLIC-3			G3
MAAPLIC-4			G4
MAAPLIC-5			G5
MAAPLIC-2			ECOALF

Maarten Chair

2012, BY VICTOR CARRASCO

Needed fabric for material:
 1.40 m wide:
 Smooth upholstery: 1.1 m
 Soft upholstery: 1.1 m

Smooth upholstery

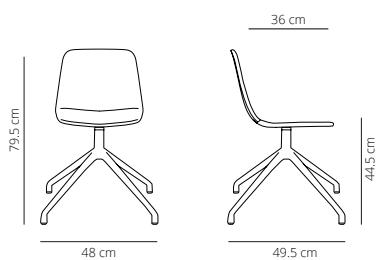

9.6 kg
 (x1) 52x52x84cm (0.23 m³)

CODE	FINISHES	
	STRUCTURE	UPHOLSTERY
MAALPI-1	white, black (microtexturized)	G1 (COM/COL)
MAALPI-2		G2
MAALPI-3		G3
MAALPI-4		G4
MAALPI-5		G5
MAALPI-2		ECOALF

Soft upholstery

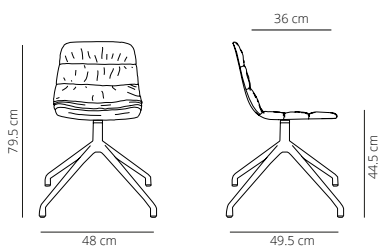

9.6 kg
 (x1) 52x52x84cm (0.23 m³)

QUICK EXPEDITION
 15 BUSINESS DAYS

See the full list of products on page 10

CODE	FINISHES	
	STRUCTURE	UPHOLSTERY
MAAPI-1	white, black (microtexturized)	G1 (COM/COL)
MAAPI-2		G2
MAAPI-3		G3
MAAPI-4		G4
MAAPI-5		G5
MAAPI-2		ECOALF

Maarten Chair

2012, BY VICTOR CARRASCO

CHAIRS AND STOOLS

Test certificates: UNE-EN 16139:2013vc2015 (only without armrest)

Needed fabric for material:
1.40 m wide:
Cushion: 0.7 m

Injected swivel aluminium base powder coated in thermoreinforced polyester in black or white microtexturized with black or white casters for soft floors.

PYRAMID SWIVEL WITH CASTERS BASE

Plastico

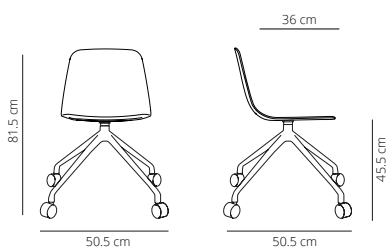

9.8 kg
(x1) 58x54x88 cm (0.28 m³)

CODE	FINISHES	
	STRUCTURE	SEAT
MAAPLPIRU	white, black (microtexturized)	white, black, taupe, dusty green, yellow ochre or brick

Plastic with cushion

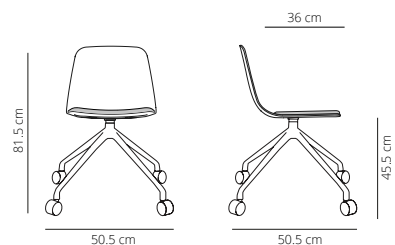

12.0 kg
(x1) 58X54X88 cm (0.28 m³)

CODE	FINISHES		
	STRUCTURE	SEAT	UPHOLSTERY
MAAPLPIRUC-1	white, black (microtexturized)	white, black, taupe, dusty green, yellow ochre or brick	G1 (COM/COL)
MAAPLPIRUC-2			G2
MAAPLPIRUC-3			G3
MAAPLPIRUC-4			G4
MAAPLPIRUC-5			G5
MAAPLPIRUC-2			ECOALF

Maarten Chair

2012, BY VICTOR CARRASCO

Needed fabric for material:
 1.40 m wide:
 Smooth upholstery: 1.1 m
 Soft upholstery: 1.1 m

Smooth upholstery

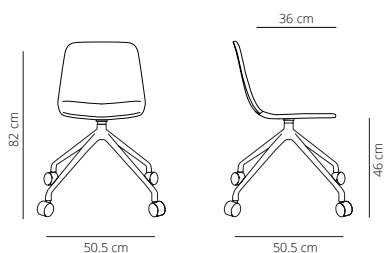

▲ 10.1 kg

📦 (x1) 58x54x88 cm (0.28 m³)

CODE	FINISHES	
	STRUCTURE	UPHOLSTERY
MAALPIRU-1	white, black (microtexturized)	G1 (COM/COL)
MAALPIRU-2		G2
MAALPIRU-3		G3
MAALPIRU-4		G4
MAALPIRU-5		G5
MAALPIRU-2		ECOALF

Soft upholstery

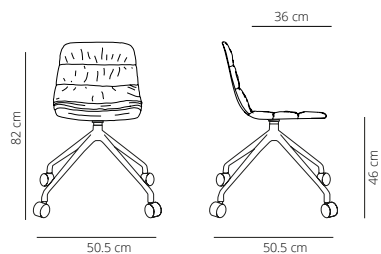

▲ 10.1 kg

📦 (x1) 58x54x88 cm (0.28 m³)



See the full list of products on page 10

CODE	FINISHES	
	STRUCTURE	UPHOLSTERY
MAAPIRU-1	white, black (microtexturized)	G1 (COM/COL)
MAAPIRU-2		G2
MAAPIRU-3		G3
MAAPIRU-4		G4
MAAPIRU-5		G5
MAAPIRU-2		ECOALF

Maarten Chair

2012, BY VICTOR CARRASCO

CHAIRS AND STOOLS

Aluminum swivel base powder coated in black or white (high gloss), height adjustment system and black or white casters for soft floors*.

*6 weeks production time.

Needed fabric for material:
1.40 m wide:
Cushion: 0.7 m

FIVE CASTERS BASE

Plastic

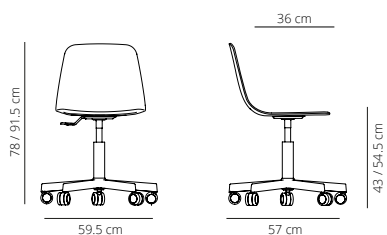

10.4 kg
(x1) 52x52x84cm (0.23 m³)

CODE	FINISHES	
	STRUCTURE	SEAT
MAAPLBR	white, black (high gloss)	white, black, taupe, dusty green, yellow ochre or brick

Plastic with cushion

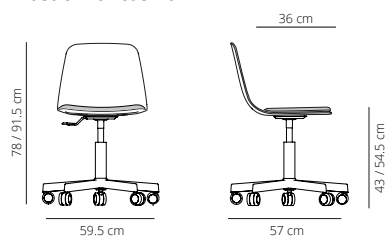

12.6 kg
(x1) 52x52x84 cm (0.23 m³)

CODE	FINISHES		
	STRUCTURE	SEAT	UPHOLSTERY
MAAPLBR-1	white, black (high gloss)	white, black, taupe, dusty green, yellow ochre or brick	G1 (COM/COL)
MAAPLBR-2			G2
MAAPLBR-3			G3
MAAPLBR-4			G4
MAAPLBR-5			G5
MAAPLBR-2			ECOALF

Maarten Chair

2012, BY VICTOR CARRASCO

Needed fabric for material:
 1.40 m wide:
 Smooth upholstery: 1.1 m
 Soft upholstery: 1.1 m

Smooth upholstery

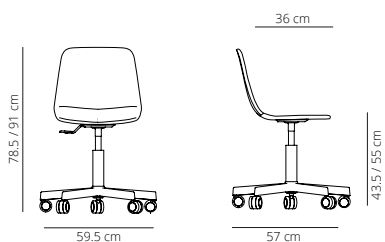

10.7 kg
 (x1) 52x52x84cm (0.23 m³)

CODE	FINISHES	
	STRUCTURE	UPHOLSTERY
MAALBR-1	white, black (high gloss)	G1 (COM/COL)
MAALBR-2		G2
MAALBR-3		G3
MAALBR-4		G4
MAALBR-5		G5
MAALBR-2		ECOALF

Soft upholstery

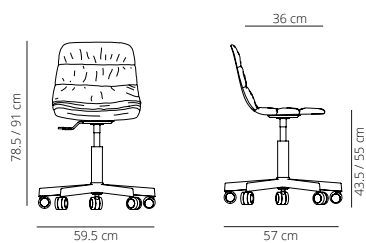

10.7 kg
 (x1) 52x52x84cm (0.23 m³)

CODE	FINISHES	
	STRUCTURE	UPHOLSTERY
MAABR-1	white, black (high gloss)	G1 (COM/COL)
MAABR-2		G2
MAABR-3		G3
MAABR-4		G4
MAABR-5		G5
MAABR-2		ECOALF

Maarten Chair

2012, BY VICTOR CARRASCO

CHAIRS AND STOOLS

Test certificates: UNE-EN 16139:2013vc2015 (only without armrest)

Needed fabric for material:
1.40 m wide:
Cushion: 0.7 m

Injected swivel aluminium base powder coated in thermoreinforced polyester in black or white microtexturized.
Black or translucent plastic glides.

FLAT SWIVEL BASE

Plastic

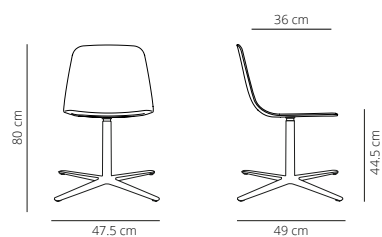

9.4 kg
(x1) 52x52x84cm (0.23 m³)

CODE	FINISHES	
	STRUCTURE	SEAT
MAAPLPLA	white, black (microtexturized)	white, black, taupe, dusty green, yellow ochre or brick

Plastic with cushion

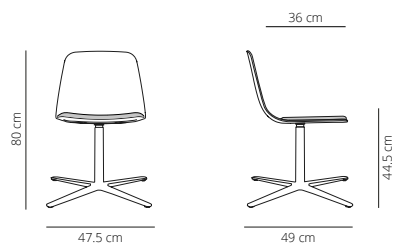

11.6 kg
(x1) 52x52x84 cm (0.23 m³)

CODE	FINISHES		
	STRUCTURE	SEAT	UPHOLSTERY
MAAPLPLAC-1	white, black (microtexturized)	white, black, taupe, dusty green, yellow ochre or brick	G1 (COM/COL)
MAAPLPLAC-2			G2
MAAPLPLAC-3			G3
MAAPLPLAC-4			G4
MAAPLPLAC-5			G5
MAAPLPLAC-2			ECOALF

Maarten Chair

2012, BY VICTOR CARRASCO

Needed fabric for material:
 1.40 m wide:
 Smooth upholstery: 1.1 m
 Soft upholstery: 1.1 m

Smooth upholstery

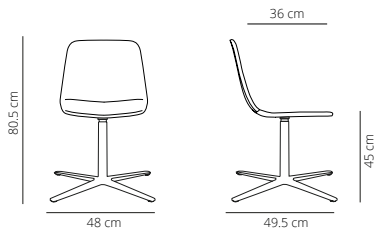

9.7 kg

(x1) 52x52x84cm (0.23 m³)

CODE	FINISHES	
	STRUCTURE	UPHOLSTERY
MAALPLA-1	white, black (microtexturized)	G1 (COM/COL)
MAALPLA-2		G2
MAALPLA-3		G3
MAALPLA-4		G4
MAALPLA-5		G5
MAALPLA-2		ECOALF

Soft upholstery

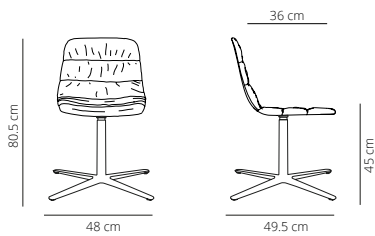

9.7 kg

(x1) 52x52x84cm (0.23 m³)

CODE	FINISHES	
	STRUCTURE	UPHOLSTERY
MAAPLA-1	white, black (microtexturized)	G1 (COM/COL)
MAAPLA-2		G2
MAAPLA-3		G3
MAAPLA-4		G4
MAAPLA-5		G5
MAAPLA-2		ECOALF

Maarten Chair

2012, BY VICTOR CARRASCO

CHAIRS AND STOOLS

Test certificates: UNE-EN 16139:2013vc2015 (only without armrest)

Needed fabric for material:
1.40 m wide:
Cushion: 0.7 m

Calibrated steel swivel structure finished with oak veneer stained with the finishes of our collection. Clear polypropylene injection glides.

NOTE: Due to the fact that the wood used is natural, the finish may vary.

WOODEN SWIVEL BASE

Plastic

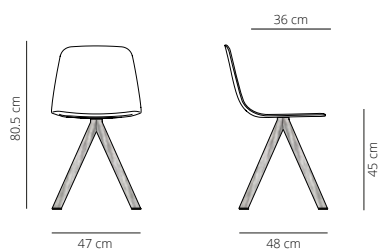

9.9 kg

(x1) 52x52x84cm (0.23 m³)

CODE	FINISHES	
	STRUCTURE	SEAT
MAAPLM	matt oak, cognac, ash or wenge	white, black, taupe, dusty green, yellow ochre or brick

Plastic with cushion

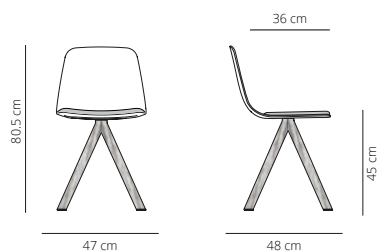

12.1 kg

(x1) 52x52x84 cm (0.23 m³)

CODE	FINISHES		
	STRUCTURE	SEAT	UPHOLSTERY
MAAPLMC-1	matt oak, cognac, ash or wenge	white, black, taupe, dusty green, yellow ochre or brick	G1 (COM/COL)
MAAPLMC-2			G2
MAAPLMC-3			G3
MAAPLMC-4			G4
MAAPLMC-5			G5
MAAPLMC-2			ECOALF

Maarten Chair

2012, BY VICTOR CARRASCO

Needed fabric for material:
1.40 m wide:
Smooth upholstery: 1.1 m
Soft upholstery: 1.1 m

Smooth upholstery

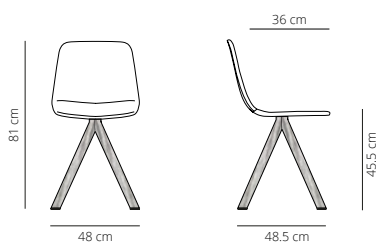

10.2 kg
(x1) 52x52x84cm (0.23 m³)

CODE	FINISHES	
	STRUCTURE	UPHOLSTERY
MAALM-1	matt oak, cognac, ash or wenge	G1 (COM/COL)
MAALM-2		G2
MAALM-3		G3
MAALM-4		G4
MAALM-5		G5
MAALM-2		ECOALF

Soft upholstery

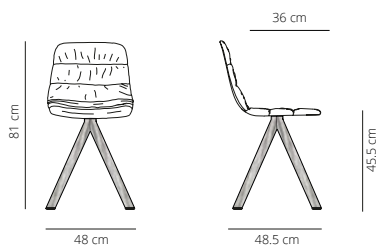

10.2 kg
(x1) 52x52x84cm (0.23 m³)

QUICK EXPEDITION
15
BUSINESS DAYS

See the full list of products on page 10

CODE	FINISHES	
	STRUCTURE	UPHOLSTERY
MAAM-1	matt oak, cognac, ash or wenge	G1 (COM/COL)
MAAM-2		G2
MAAM-3		G3
MAAM-4		G4
MAAM-5		G5
MAAM-2		ECOALF

Maarten Chair

2012, BY VICTOR CARRASCO

CHAIRS AND STOOLS

Four solid oak wood legs upholstered with leather or ecoleather.
Plastic glides with or without felt.*

Needed fabric for material:
1.40 m wide:
Cushion: 0.7 m

FOUR UPHOLSTERED LEGS BASE

Plastic

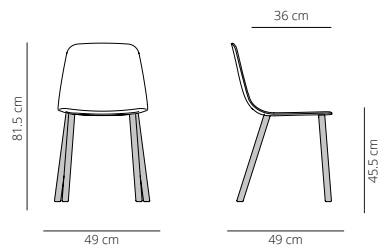

7.3 kg
(x1) 55x55x88 cm (0.27 m³)

CODE	FINISHES	
	STRUCTURE	SEAT
MAAPL4PTP	ecoleather	white, black, taupe, dusty green, yellow ochre or brick
MAAPL4PTL	leather	white, black, taupe, dusty green, yellow ochre or brick

Plastic with cushion

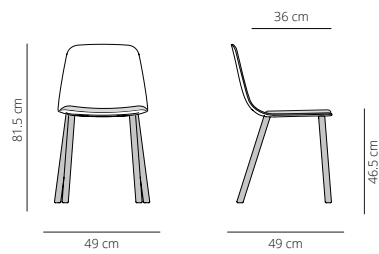

8.4 kg
(x1) 55x55x88 cm (0.27 m³)

CODE	FINISHES		
	STRUCTURE	SEAT	UPHOLSTERY
MAAPL4PTPC-1	ecoleather	white, black, taupe, dusty green, yellow ochre or brick	G1 (COM/COL)
MAAPL4PTPC-2			G2
MAAPL4PTPC-3			G3
MAAPL4PTPC-4			G4
MAAPL4PTPC-5			G5
MAAPL4PTPC-2			ECOALF
MAAPL4PTLC-1	leather	white, black, taupe, dusty green, yellow ochre or brick	G1 (COM/COL)
MAAPL4PTLC-2			G2
MAAPL4PTLC-3			G3
MAAPL4PTLC-4			G4
MAAPL4PTLC-5			G5
MAAPL4PTLC-2			ECOALF

Maarten Chair

2012, BY VICTOR CARRASCO

Needed fabric for material:
 1.40 m wide:
Smooth upholstery: 1.1 m
Soft upholstery: 1.1 m

Smooth upholstery

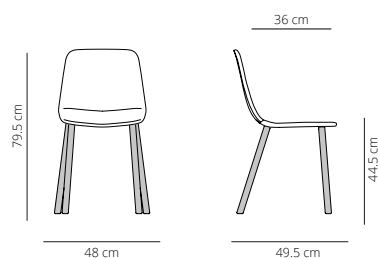

8.3 kg
 (x1) 55x55x88 cm (0.27 m³)

CODE	FINISHES	
	STRUCTURE	UPHOLSTERY
MAAL4PTP-1	ecoleather	G1 (COM/COL)
MAAL4PTP-2		G2
MAAL4PTP-3		G3
MAAL4PTP-4		G4
MAAL4PTP-5		G5
MAAL4PTP-2		ECOALF
MAAL4PTL-1	leather	G1 (COM/COL)
MAAL4PTL-2		G2
MAAL4PTL-3		G3
MAAL4PTL-4		G4
MAAL4PTL-5		G5
MAAL4PTL-2		ECOALF

Soft upholstery

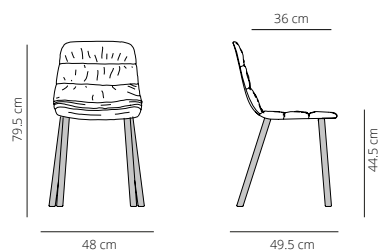

8.6 kg
 (x1) 55x55x88 cm (0.27 m³)

CODE	FINISHES	
	STRUCTURE	UPHOLSTERY
MAA4PTP-1	ecoleather	G1 (COM/COL)
MAA4PTP-2		G2
MAA4PTP-3		G3
MAA4PTP-4		G4
MAA4PTP-5		G5
MAA4PTP-2		ECOALF
MAA4PTL-1	leather	G1 (COM/COL)
MAA4PTL-2		G2
MAA4PTL-3		G3
MAA4PTL-4		G4
MAA4PTL-5		G5
MAA4PTL-2		ECOALF

Maarten Chair

2012, BY VICTOR CARRASCO

CHAIRS AND STOOLS

Test certificates: UNE-EN 16139:2013vc2015 (only without armrest)

Calibrated steel swivel structure upholstered with leather or ecoleather.
Clear polypropylene injection glides.

Needed fabric for material:
1.40 m wide:
Cushion: 0.7 m

UPHOLSTERED SWIVEL BASE

Plastic

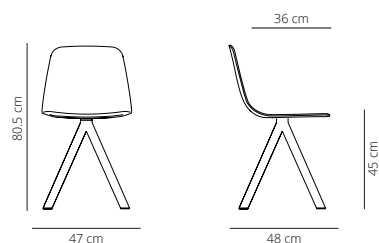

9.9 kg
(x1) 52x52x84cm (0.23 m³)

CODE	FINISHES	
	STRUCTURE	SEAT
MAAPLPGTP	ecoleather	white, black, taupe, dusty green, yellow ochre or brick
MAAPLPGTL	leather	white, black, taupe, dusty green, yellow ochre or brick

Plastic with cushion

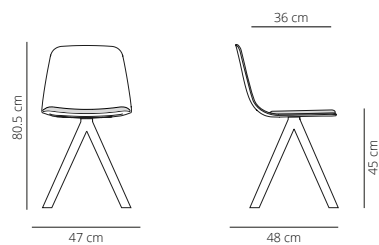

12.1 kg
(x1) 52x52x84 cm (0.23 m³)

CODE	FINISHES		
	STRUCTURE	SEAT	UPHOLSTERY
MAAPLPGTPC-1	ecoleather	white, black, taupe, dusty green, yellow ochre or brick	G1 (COM/COL)
MAAPLPGTPC-2			G2
MAAPLPGTPC-3			G3
MAAPLPGTPC-4			G4
MAAPLPGTPC-5			G5
MAAPLPGTPC-2			ECOALF
MAAPLPGTLC-1	leather	white, black, taupe, dusty green, yellow ochre or brick	G1 (COM/COL)
MAAPLPGTLC-2			G2
MAAPLPGTLC-3			G3
MAAPLPGTLC-4			G4
MAAPLPGTLC-5			G5
MAAPLPGTLC-2			ECOALF

Maarten Chair

2012, BY VICTOR CARRASCO

Needed fabric for material:
 1.40 m wide:
Smooth upholstery: 1.1 m
Soft upholstery: 1.1 m

Smooth upholstery

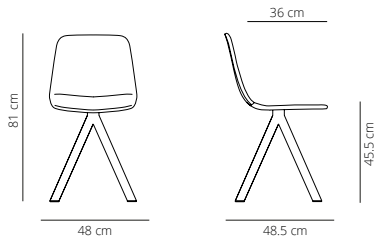

10.2 kg
 (x1) 52x52x84cm (0.23 m³)

CODE	FINISHES	
	STRUCTURE	UPHOLSTERY
MAALPGTP-1	ecoleather	G1 (COM/COL)
MAALPGTP-2		G2
MAALPGTP-3		G3
MAALPGTP-4		G4
MAALPGTP-5		G5
MAALPGTP-2		ECOALF
MAALPGTL-1	leather	G1 (COM/COL)
MAALPGTL-2		G2
MAALPGTL-3		G3
MAALPGTL-4		G4
MAALPGTL-5		G5
MAALPGTL-2		ECOALF

Soft upholstery

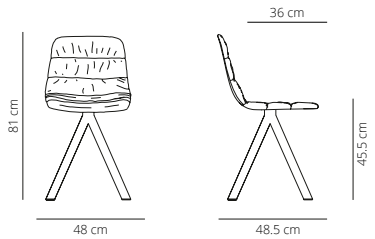

10.2 kg
 (x1) 52x52x84cm (0.23 m³)

CODE	FINISHES	
	STRUCTURE	UPHOLSTERY
MAAPGTP-1	ecoleather	G1 (COM/COL)
MAAPGTP-2		G2
MAAPGTP-3		G3
MAAPGTP-4		G4
MAAPGTP-5		G5
MAAPGTP-2		ECOALF
MAAPGTL-1	leather	G1 (COM/COL)
MAAPGTL-2		G2
MAAPGTL-3		G3
MAAPGTL-4		G4
MAAPGTL-5		G5
MAAPGTL-2		ECOALF

Maarten Chair

2012, BY VICTOR CARRASCO

CHAIRS AND STOOLS

Test certificates: ANSI BIFMA X5.4-2020 and UNE EN 16139:2013vc2015

Calibrated steel structure and footrest powder coated in thermoreinforced polyester in white, or black. Black or white plastic glides.

Needed fabric for material:
1.40 m wide:
Smooth upholstery: 1 m
Soft upholstery: 1 m

SLED COUNTER STOOL BASE

Plastic low backrest

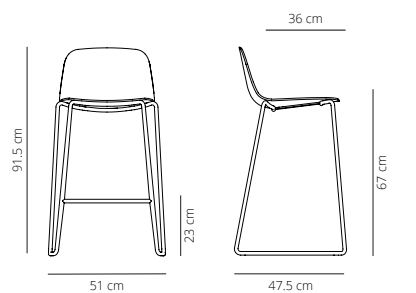

14.4 kg
(x1) 58x56x120 cm (0.39 m³)



CODE	FINISHES	
	STRUCTURE	SEAT
MAALPTPCOB	white, black	white, black, taupe, dusty green, yellow ochre or brick

Smooth upholstered low backrest

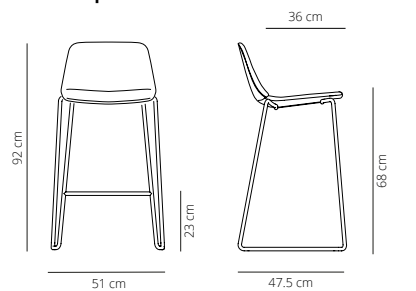

15.2 kg
(x1) 58x56x100 cm (0.32 m³)



CODE	FINISHES	
	STRUCTURE	UPHOLSTERY
MAALPTCOB-1	white, black	G1 (COM/COL)
MAALPTCOB-2		G2
MAALPTCOB-3		G3
MAALPTCOB-4		G4
MAALPTCOB-5		G5
MAALPTCOB-2		ECOALF

Soft upholstered low backrest

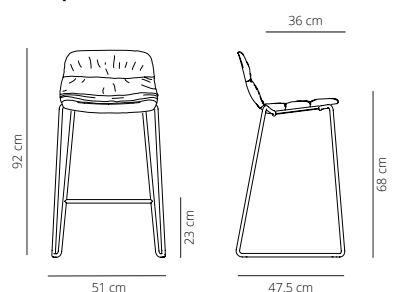

15.6 kg
(x1) 58x56x100 cm (0.32 m³)



CODE	FINISHES	
	STRUCTURE	UPHOLSTERY
MAATPCOB-1	white, black	G1 (COM/COL)
MAATPCOB-2		G2
MAATPCOB-3		G3
MAATPCOB-4		G4
MAATPCOB-5		G5
MAATPCOB-2		ECOALF

Test certificates: ANSI BIFMA X5.4-2020 and UNE EN 16139:2013vc2015

Calibrated steel structure and footrest powder coated in thermoreinforced polyester in white, or black. Black or white plastic glides.

Needed fabric for material:
1.40 m wide:
Smooth upholstery: 1 m
Soft upholstery: 1 m

SLED BAR STOOL BASE

Plastic low backrest

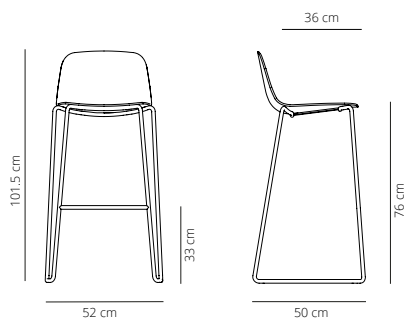

8.4 kg
(x1) 58x56x120 cm (0.35 m³) x4 Stackable up to 4 units

CODE	FINISHES	
	STRUCTURE	SEAT
MAALPTPTBARB	white, black	white, black, taupe, dusty green, yellow ochre or brick

Smooth upholstered low backrest

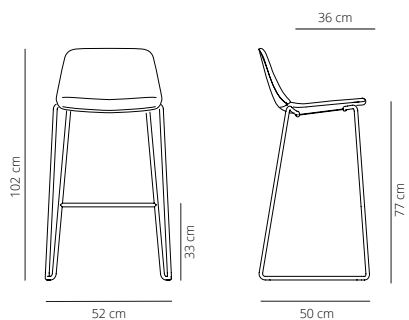

8.8 kg
(x1) 58x56x108 cm (0.35 m³) x4 Stackable up to 4 units

CODE	FINISHES	
	STRUCTURE	UPHOLSTERY
MAALPTPTBARB-1	white, black	G1 (COM/COL)
MAALPTPTBARB-2		G2
MAALPTPTBARB-3		G3
MAALPTPTBARB-4		G4
MAALPTPTBARB-5		G5
MAALPTPTBARB-2		ECOALF

Soft upholstered low backrest

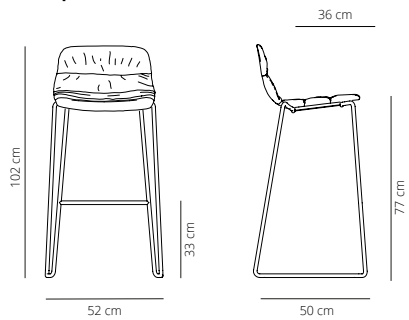

9.0 kg
(x1) 58x56x108 cm (0.35 m³) x4 Stackable up to 4 units

CODE	FINISHES	
	STRUCTURE	UPHOLSTERY
MAATPTBARB-1	white, black	G1 (COM/COL)
MAATPTBARB-2		G2
MAATPTBARB-3		G3
MAATPTBARB-4		G4
MAATPTBARB-5		G5
MAATPTBARB-2		ECOALF

Maarten Chair

2012, BY VICTOR CARRASCO

CHAIRS AND STOOLS

Calibrated steel swivel structure powder coated in thermoreinforced polyester in white, black, taupe or fluorescent orange. Black or white plastic glides with or without felt.*

Needed fabric for material:
1.40 m wide:
Smooth upholstery: 1 m
Soft upholstery: 1 m

SWIVEL COUNTER STOOL BASE

Plastic low backrest

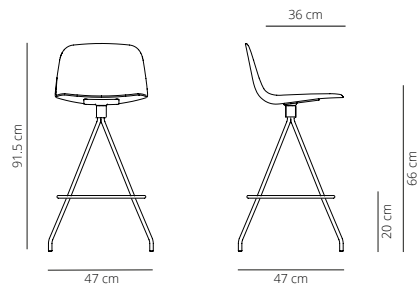

8.4 kg
(x1) 54x54x97 cm (0.28 m³)

CODE	FINISHES	
	STRUCTURE	SEAT
MAAPLCOB	white, black	white, black, taupe, dusty green, yellow ochre or brick

Smooth upholstered low backrest

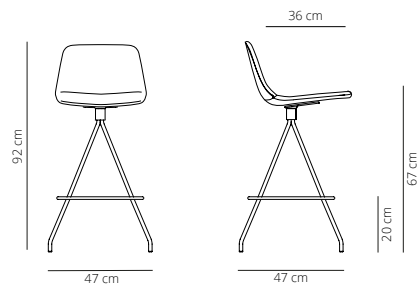

8.8 kg
(x1) 54x54x97 cm (0.28 m³)

CODE	FINISHES	
	STRUCTURE	UPHOLSTERY
MAALTCOB-1	white, black	G1 (COM/COL)
MAALTCOB-2		G2
MAALTCOB-3		G3
MAALTCOB-4		G4
MAALTCOB-5		G5
MAALTCOB-2		ECOALF

Soft upholstered low backrest

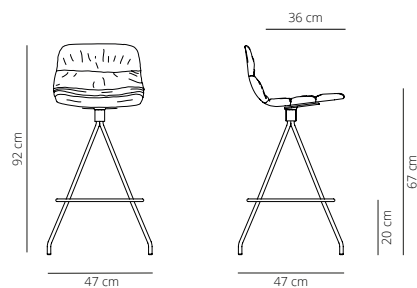

9.0 kg
(x1) 54x54x97 cm (0.28 m³)

CODE	FINISHES	
	STRUCTURE	UPHOLSTERY
MAATCOB-1	white, black	G1 (COM/COL)
MAATCOB-2		G2
MAATCOB-3		G3
MAATCOB-4		G4
MAATCOB-5		G5
MAATCOB-2		ECOALF

Maarten Chair

2012, BY VICTOR CARRASCO

CHAIRS AND STOOLS

Calibrated steel swivel structure powder coated in thermoreinforced polyester in white, black, taupe or fluorescent orange. Black or white plastic glides wit or without felt.*

Needed fabric for material:
1.40 m wide:
Smooth upholstery: 1 m
Soft upholstery: 1 m

SWIVEL BAR STOOL BASE

Plastic low backrest

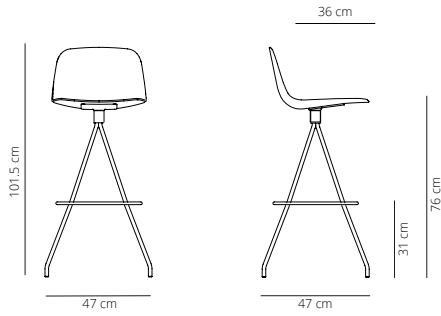

8.8 kg
(x1) 54x54x108 cm (0.31 m³)

CODE	FINISHES	
	STRUCTURE	SEAT
MAAPLBARB	white, black	white, black, taupe, dusty green, yellow ochre or brick

Smooth upholstered low backrest

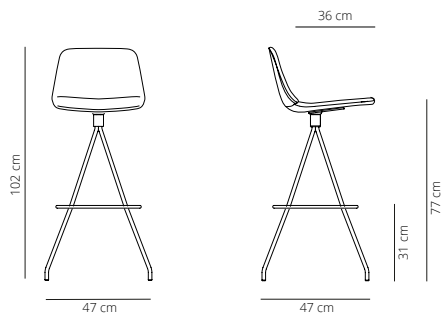

9.2 kg
(x1) 54x54x108 cm (0.31 m³)

CODE	FINISHES	
	STRUCTURE	UPHOLSTERY
MAALTBARB-1	white, black	G1 (COM/COL)
MAALTBARB-2		G2
MAALTBARB-3		G3
MAALTBARB-4		G4
MAALTBARB-5		G5
MAALTBARB-2		ECOALF

Soft upholstered low backrest

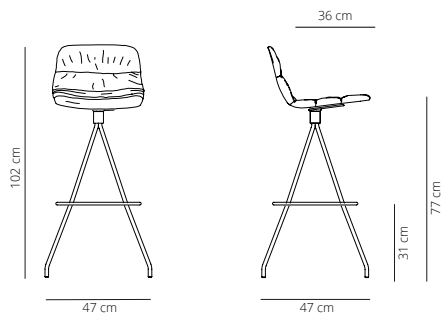

9.4kg
(x1) 54x54x108 cm (0.31 m³)

CODE	FINISHES	
	STRUCTURE	UPHOLSTERY
MAATBARB-1	white, black	G1 (COM/COL)
MAATBARB-2		G2
MAATBARB-3		G3
MAATBARB-4		G4
MAATBARB-5		G5
MAATBARB-2		ECOALF

Maarten Chair

2012, BY VICTOR CARRASCO

CHAIRS AND STOOLS

Four solid oak wood legs stained with the finishes for our collection. Calibrated steel footrest powder coated in black thermoreinforced polyester. Plastic glides with or without felt.*

Needed fabric for material:
1.40 m wide:
Smooth upholstery: 1 m
Soft upholstery: 1 m

FOUR WOODEN LEGS COUNTER STOOL BASE

Plastic low backrest

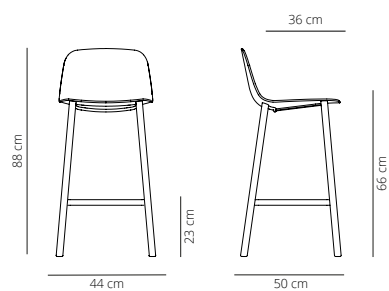

8.6 kg
(x1) 58x56x99 cm (0.32 m³)

CODE	FINISHES	
	STRUCTURE	SEAT
MAAPLT4MCOB	matt oak, cognac, ash or wenge	white, black, taupe, dusty green, yellow ochre or brick

Smooth upholstered low backrest

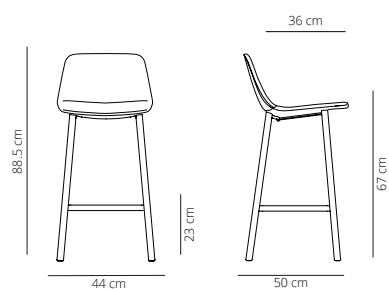

9.0 kg
(x1) 58x56x99 cm (0.32 m³)

CODE	FINISHES	
	STRUCTURE	UPHOLSTERY
MAALT4MCOB-1	matt oak, cognac, ash or wenge	G1 (COM/COL)
MAALT4MCOB-2		G2
MAALT4MCOB-3		G3
MAALT4MCOB-4		G4
MAALT4MCOB-5		G5
MAALT4MCOB-2		ECOALF

Soft upholstered low backrest

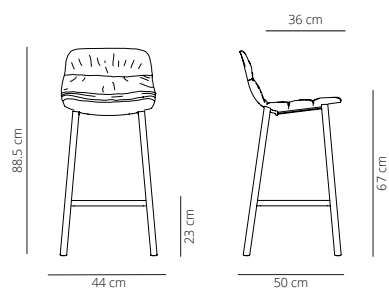

9.2 kg
(x1) 58x56x99 cm (0.32 m³)

CODE	FINISHES	
	STRUCTURE	UPHOLSTERY
MAAT4MCOB-1	matt oak, cognac, ash or wenge	G1 (COM/COL)
MAAT4MCOB-2		G2
MAAT4MCOB-3		G3
MAAT4MCOB-4		G4
MAAT4MCOB-5		G5
MAAT4MCOB-2		ECOALF

CHAIRS AND STOOLS

Maarten Chair

2012, BY VICTOR CARRASCO

Four solid oak wood legs stained with the finishes for our collection. Calibrated steel footrest powder coated in black thermoreinforced polyester. Plastic glides with or without felt.*

Needed fabric for material:
1.40 m wide:
Smooth upholstery: 1 m
Soft upholstery: 1 m

FOUR WOODEN LEGS BAR STOOL BASE

Plastic low backrest

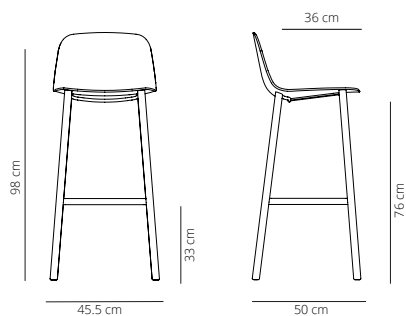

9.0 kg
(x1) 58x56x108 cm (0.35 m³)

CODE	FINISHES	
	STRUCTURE	SEAT
MAAPLT4MBARB	matt oak, cognac, ash or wenge	white, black, taupe, dusty green, yellow ochre or brick

Smooth upholstered low backrest

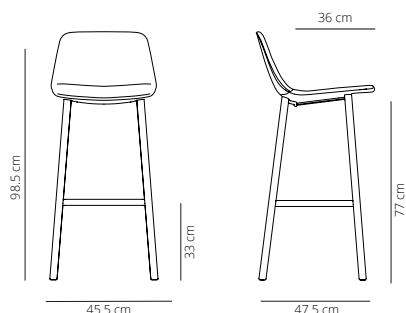

9.4 kg
(x1) 58x56x108 cm (0.35 m³)

CODE	FINISHES	
	STRUCTURE	UPHOLSTERY
MAALT4MBARB-1	matt oak, cognac, ash or wenge	G1 (COM/COL)
MAALT4MBARB-2		G2
MAALT4MBARB-3		G3
MAALT4MBARB-4		G4
MAALT4MBARB-5		G5
MAALT4MBARB-2		ECOALF

Soft upholstered low backrest

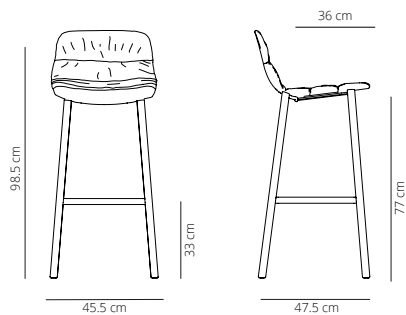

9.6 kg
(x1) 58x56x108 cm (0.35 m³)

CODE	FINISHES	
	STRUCTURE	UPHOLSTERY
MAAT4MBARB-1	matt oak, cognac, ash or wenge	G1 (COM/COL)
MAAT4MBARB-2		G2
MAAT4MBARB-3		G3
MAAT4MBARB-4		G4
MAAT4MBARB-5		G5
MAAT4MBARB-2		ECOALF

Maarten Chair

2012, BY VICTOR CARRASCO

CHAIRS AND STOOLS

Calibrated steel swivel structure powder coated in thermoreinforced polyester in white, black, taupe or fluorescent orange. Black or white plastic glides with or without felt.*

Needed fabric for material:
1.40 m wide:
Cushion: 0.7 m

SWIVEL COUNTER STOOL BASE

Plastic high backrest

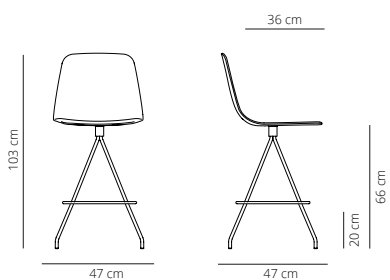

9.7 kg

(x1) 57.5x53.5x110 cm (0.33 m³)

CODE	FINISHES	
	STRUCTURE	SEAT
MAAPLCO	white, black	white, black, taupe, dusty green, yellow ochre or brick
	taupe or fluorescent orange	white, black, taupe, dusty green, yellow ochre or brick

Plastic high backrest with cushion

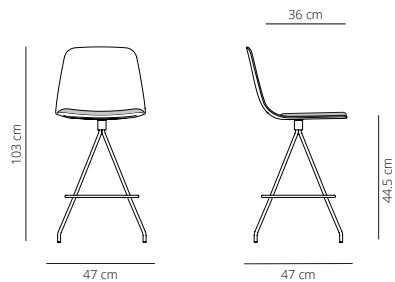

11.9 kg

(x1) 57.5x53.5x110 cm (0.33 m³)

CODE	FINISHES		
	STRUCTURE	SEAT	UPHOLSTERY
MAAPLCO-1	white, black	white, black, taupe, dusty green, yellow ochre or brick	G1 (COM/COL)
MAAPLCO-2			G2
MAAPLCO-3			G3
MAAPLCO-4			G4
MAAPLCO-5			G5
MAAPLCO-2			ECOALF
MAAPLCO-1	taupe or fluorescent orange	white, black, taupe, dusty green, yellow ochre or brick	G1 (COM/COL)
MAAPLCO-2			G2
MAAPLCO-3			G3
MAAPLCO-4			G4
MAAPLCO-5			G5
MAAPLCO-2			ECOALF

Needed fabric for material:
 1.40 m wide:
 Smooth upholstery: 1.1 m
 Soft upholstery: 1.1 m

Smooth upholstered high backrest

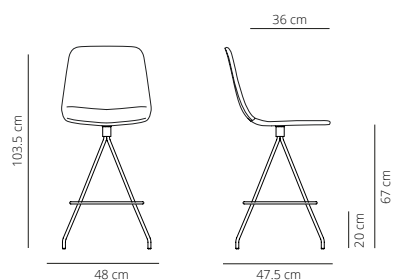

10 kg

(x1) 57.5x53.5x110 cm (0.33 m³)

CODE	FINISHES	
	STRUCTURE	UPHOLSTERY
MAALTCO-1	white, black	G1 (COM/COL)
MAALTCO-2		G2
MAALTCO-3		G3
MAALTCO-4		G4
MAALTCO-5		G5
MAALTCO-2		ECOALF
MAALTCO-1	taupe or fluorescent orange	G1 (COM/COL)
MAALTCO-2		G2
MAALTCO-3		G3
MAALTCO-4		G4
MAALTCO-5		G5
MAALTCO-2		ECOALF

Soft upholstered high backrest

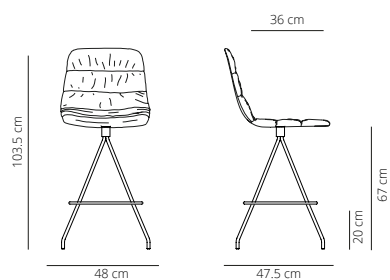

10 kg

(x1) 57.5x53.5x110cm (0.33 m³)

CODE	FINISHES	
	STRUCTURE	UPHOLSTERY
MAATCO-1	white, black	G1 (COM/COL)
MAATCO-2		G2
MAATCO-3		G3
MAATCO-4		G4
MAATCO-5		G5
MAATCO-2		ECOALF
MAATCO-1	taupe or fluorescent orange	G1 (COM/COL)
MAATCO-2		G2
MAATCO-3		G3
MAATCO-4		G4
MAATCO-5		G5
MAATCO-2		ECOALF

Maarten Chair

2012, BY VICTOR CARRASCO

CHAIRS AND STOOLS

Calibrated steel swivel structure powder coated in thermoreinforced polyester in white, black, taupe or fluorescent orange. Black or white plastic glides with or without felt.*

Needed fabric for material:
1.40 m wide:
Cushion: 0.7 m

SWIVEL BAR STOOL BASE

Plastic high backrest

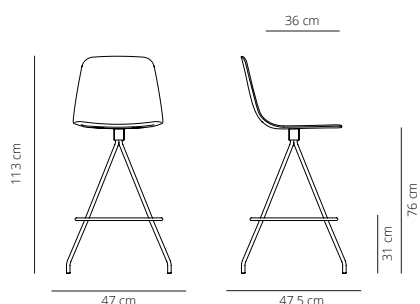

11.1 kg

(x1) 57.5x53.5x120 cm (0.37 m³)

CODE	FINISHES	
	STRUCTURE	SEAT
MAAPLBAR	white, black	white, black, taupe, dusty green, yellow ochre or brick
	taupe or fluorescent orange	white, black, taupe, dusty green, yellow ochre or brick

Plastic high backrest with cushion

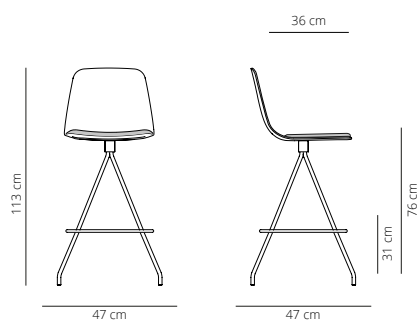

13.3 kg

(x1) 57.5x53.5x120 cm (0.37 m³)

CODE	FINISHES		
	STRUCTURE	SEAT	UPHOLSTERY
MAAPLBARC-1	white, black	white, black, taupe, dusty green, yellow ochre or brick	G1 (COM/COL)
MAAPLBARC-2			G2
MAAPLBARC-3			G3
MAAPLBARC-4			G4
MAAPLBARC-5			G5
MAAPLBARC-2			ECOALF
MAAPLBARC-1	taupe or fluorescent orange	white, black, taupe, dusty green, yellow ochre or brick	G1 (COM/COL)
MAAPLBARC-2			G2
MAAPLBARC-3			G3
MAAPLBARC-4			G4
MAAPLBARC-5			G5
MAAPLBARC-2			ECOALF

Needed fabric for material:
 1.40 m wide:
Smooth upholstery: 1.1 m
Soft upholstery: 1.1 m

Smooth upholstered high backrest

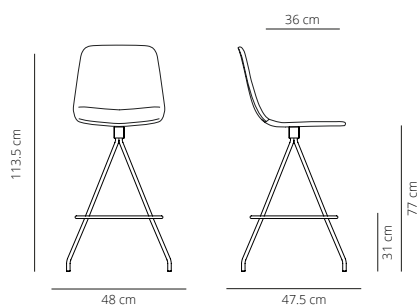

11.4 kg
 (x1) 57.5x53.5x120 cm (0.37 m³)

CODE	FINISHES	
	STRUCTURE	UPHOLSTERY
MAALTBAR-1	white, black	G1 (COM/COL)
MAALTBAR-2		G2
MAALTBAR-3		G3
MAALTBAR-4		G4
MAALTBAR-5		G5
MAALTBAR-2		ECOALF
MAALTBAR-1	taupe or fluorescent orange	G1 (COM/COL)
MAALTBAR-2		G2
MAALTBAR-3		G3
MAALTBAR-4		G4
MAALTBAR-5		G5
MAALTBAR-2		ECOALF

Soft upholstered high backrest

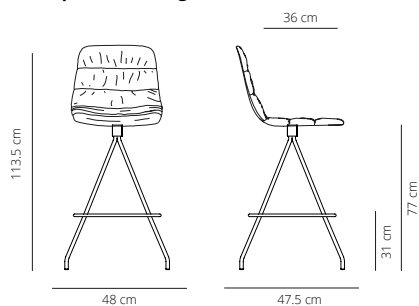

11.4 kg
 (x1) 57.5x53.5x120 cm (0.37 m³)

CODE	FINISHES	
	STRUCTURE	UPHOLSTERY
MAATBAR-1	white, black	G1 (COM/COL)
MAATBAR-2		G2
MAATBAR-3		G3
MAATBAR-4		G4
MAATBAR-5		G5
MAATBAR-2		ECOALF
MAATBAR-1	taupe or fluorescent orange	G1 (COM/COL)
MAATBAR-2		G2
MAATBAR-3		G3
MAATBAR-4		G4
MAATBAR-5		G5
MAATBAR-2		ECOALF

Maarten Chair

2012, BY VICTOR CARRASCO

CHAIRS AND STOOLS

AUDITORIUM BASE

Plastic

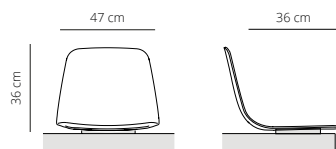

12.7 kg

(x1) 53x53x53 cm (0.15 m³)*

*The package contain 2 units.

CODE	FINISHES	
	STRUCTURE	SEAT
MAAPLAU	grey	white, black, taupe, dusty green, yellow ochre or brick

NOTE: Price per unit.

Injected polypropylene seat in white, black, taupe, dusty green, yellow ochre or brick.

Screws or anchoring system not included.

Plastic with cushion

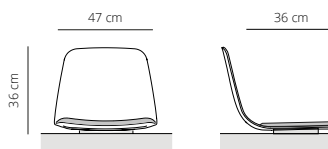

12.7 kg

(x1) 53x53x53 cm (0.15 m³)*

*The package contain 2 units.

CODE	FINISHES		
	STRUCTURE	SEAT	UPHOLSTERY
MAAPLAUC-1	grey	white, black, taupe, dusty green, yellow ochre or brick	G1 (COM/COL)
MAAPLAUC-2			G2
MAAPLAUC-3			G3
MAAPLAUC-4			G4
MAAPLAUC-5			G5
MAAPLAUC-2			ECOALF

NOTE: Price per unit.

Injected polypropylene seat in white, black, taupe, dusty green, yellow ochre or brick and seat cushion.

Screws or anchoring system not included.

Smooth upholstery

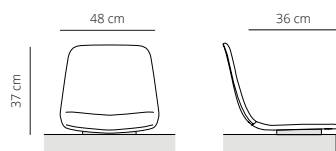

13.3 kg

(x1) 53x53x53 cm (0.15 m³)*

*The package contain 2 units.

CODE	FINISHES	
	STRUCTURE	UPHOLSTERY
MAALAU-1	grey	G1 (COM/COL)
MAALAU-2		G2
MAALAU-3		G3
MAALAU-4		G4
MAALAU-5		G5
MAALAU-2		ECOALF

NOTE: Price per unit.

Injected polypropylene seat in smooth upholstery.

Screws or anchoring system not included.

Soft upholstery

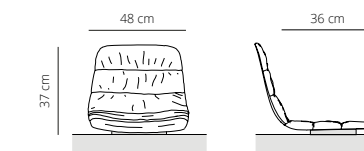

13.3 kg

(x1) 53x53x53 cm (0.15 m³)*

*The package contain 2 units.

CODE	FINISHES	
	STRUCTURE	UPHOLSTERY
MAAAU-1	grey	G1 (COM/COL)
MAAAU-2		G2
MAAAU-3		G3
MAAAU-4		G4
MAAAU-5		G5
MAAAU-2		ECOALF

NOTE: Price per unit.

Injected polypropylene seat in soft upholstery.

Screws or anchoring system not included.

ACCESSORIES

Metal armrest

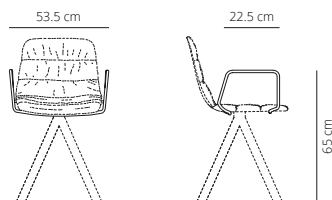

1.1 kg

Included and fitted on the chair

CODE	FINISHES	
	STRUCTURE	
MAB	white, black, taupe or fluorescent orange	

Calibrated steel armrest powder coated in thermoreinforced polyester in black, white, taupe or fluorescent orange. Available for all bases and seats but the auditorium base.

Wooden armrest

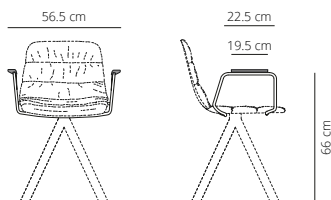

1.4 kg

Included and fitted on the chair

CODE	FINISHES	
	STRUCTURE	STAIN
MAABRM	white, black, taupe or fluorescent orange	matt oak, cognac, ash or wenge

Calibrated steel armrest powder coated in thermoreinforced polyester in black, white, taupe or fluorescent orange, with natural oak armrests stained with the finishes of our collection. Available for all bases and seats but the auditorium base.

NOTE: Due to the fact that the wood used is natural, the finish may vary.

Upholstered armrest

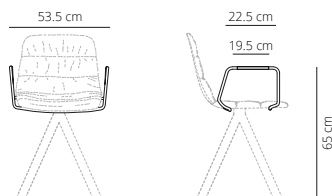

1.1 kg

Included and fitted on the chair

CODE	FINISHES	
	STRUCTURE	UPHOLSTERY
MAABRTP	white, black, taupe or fluorescent orange	ecoleather
MAABRTL		leather

Calibrated steel armrest powder coated in thermoreinforced polyester in black, white, taupe or fluorescent orange and upholstered with leather or ecoleather.

Available for all bases and seats but the auditorium base.

Side table

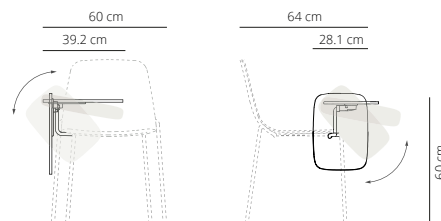

2.3 kg

Included and fitted on the chair

CODE	CHAIR	FINISHES	
		STRUCTURE	SIDETABLE
MAAL4P-PALAD	four metal legs base	white, black, taupe or fluorescent orange	black
MAAL4P-PALAI			
MAALPT-PALAD	sled base		
MAALPT-PALAI			

HPL sidetable with aluminum mechanism and anti-panic system. Left or right handed versions. Available only for four metal legs base.