

kendo

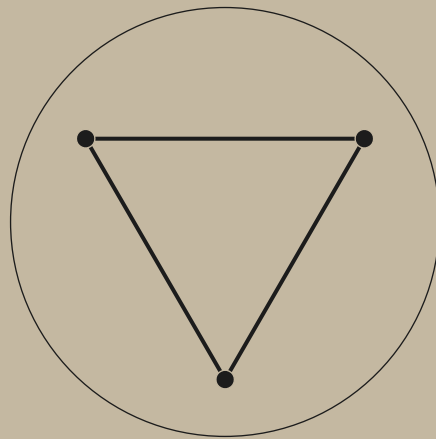

VILLA

Side / coffee table

Designed by OrtegaGuijarro

Villa

OrtegaGuijarro

Colección de mesas de centro y auxiliares compuesta por una tapa circular de cristal templado, transparente o fumé gris. La estructura es de metal negro termolacado microtexturado.

Collection of coffee and occasional tables comprising a circular transparent or smoked grey tempered glass top. The structure is in micro-textured black thermo-lacquered metal structure.

Mesas auxiliares

Side tables

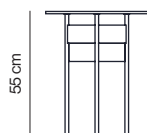

Ø45 cm

VIL-45

Ø45x55 cm

0,165 m³ 10 Kg

Tapa cristal transparente / Estructura termolacada negro microtexturado
Transparent glass top / Micro-textured black thermo-lacquered structure

Tapa cristal fumé gris / Estructura termolacada negro microtexturado
Smoked grey glass top / Micro-textured black thermo-lacquered structure

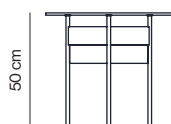

Ø55 cm

VIL-55

Ø55x50 cm

0,195 m³ 13 Kg

Tapa cristal transparente / Estructura termolacada negro microtexturado
Transparent glass top / Micro-textured black thermo-lacquered structure

Tapa cristal fumé gris / Estructura termolacada negro microtexturado
Smoked grey glass top / Micro-textured black thermo-lacquered structure

Mesas de centro

Coffee tables

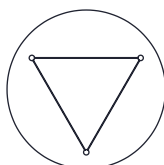
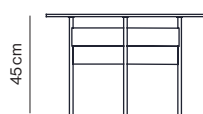

Ø70 cm

VIL-74

Ø70x45 cm

0,302 m³ 17 Kg

Tapa cristal transparente / Estructura termolacada negro microtexturado
Transparent glass top / Micro-textured black thermo-lacquered structure

Tapa cristal fumé gris / Estructura termolacada negro microtexturado
Smoked grey glass top / Micro-textured black thermo-lacquered structure

Villa

OrtegaGuijarro

Colección de mesas de centro y auxiliares compuesta por una tapa circular de cristal templado, transparente o fumé gris. La estructura es de metal negro termolacado microtexturado.

Collection of coffee and occasional tables comprising a circular transparent or smoked grey tempered glass top. The structure is in micro-textured black thermo-lacquered metal structure.

Mesas auxiliares

Side tables

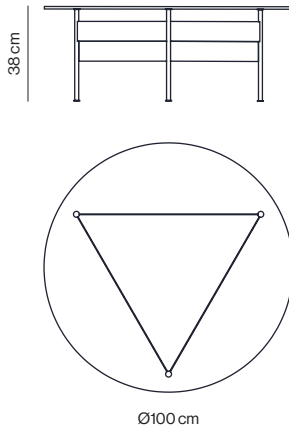

VIL-03

Ø100x38 cm

0,320 m³ 27 Kg

Tapa cristal transparente / Estructura termolacada negro microtexturado
Transparent glass top / Micro-textured black thermo-lacquered structure

Tapa cristal fumé gris / Estructura termolacada negro microtexturado
Smoked grey glass top / Micro-textured black thermo-lacquered structure

Acabados | Finishes

Colores aproximados
Approximate colours

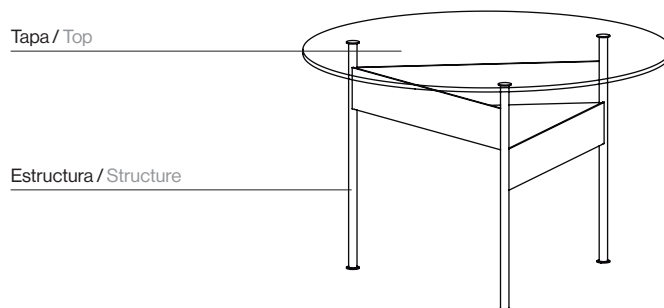

Tapa | Top

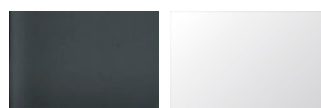

Cristal fumé gris / Smoked grey glass
Cristal transparente / Transparent glass

Estructura | Structure

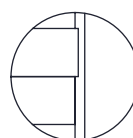

Metal negro
Black metal